

renchwell.com



**NOTE:** Right and left sides of the machine are determined by facing in the direction of forward travel. The engine is in the front.

**TRADEMARKS**

**VERMEER** and **VERMEER** Logo are trademarks of Vermeer Manufacturing Company.  
**DEUTZ** is a trademark of Kockner-Humbolt-Deutz, Germany.

RT450 Tractor/Attachments

## **VERMEER NEW INDUSTRIAL EQUIPMENT LIMITED WARRANTY**

**(EFFECTIVE OCTOBER 1, 2008)**

**WARRANTY PERIOD: 12 Months / 1000 Hours**

Vermeer Corporation (hereinafter "Vermeer") warrants each new Industrial product of Vermeer's manufacture to be free from defects in material and workmanship, under normal use and service for one (1) full year after initial purchase/retail sale or 1000 operating hours, whichever occurs first. This Limited Warranty shall apply only to complete machines of Vermeer's manufacture, parts are covered by a separate Limited Warranty. **EQUIPMENT AND ACCESSORIES NOT OF VERMEER'S MANUFACTURE ARE WARRANTED ONLY TO THE EXTENT OF THE ORIGINAL MANUFACTURER'S WARRANTY AND SUBJECT TO THEIR ALLOWANCE TO VERMEER ONLY IF FOUND DEFECTIVE BY SUCH MANUFACTURER.**

**EXTENDED WARRANTY OPTIONS ARE AVAILABLE FOR PURCHASE.**

### **WARRANTY TERMS**

During the Limited Warranty period specified above, any defect in material or workmanship in any warranted item of Vermeer Industrial Equipment not excluded below shall be repaired or replaced at Vermeer's option without charge by any authorized independent Vermeer dealer. The warranty repair or replacement must be made by a Vermeer independent authorized dealer at the dealer's location. Vermeer will pay for replacement parts and such authorized dealer's labor in accordance with Vermeer's labor reimbursement policy. Vermeer reserves the right to supply remanufactured replacement parts as it deems appropriate.

**RETAIL PURCHASER RESPONSIBILITY:** This Limited Warranty requires proper maintenance and periodic inspections of the Industrial Equipment as indicated in the Operator's/Maintenance Manual furnished with each new Industrial Equipment. The cost of routine or required maintenance and services is the responsibility of the retail purchaser. The retail purchaser is required to keep documented evidence that these services were performed.

This Vermeer New Industrial Equipment Limited Warranty may be subject to cancellation if the above requirements are not performed.

Vermeer Industrial Equipment with known failed or defective parts must be immediately removed from service.

## **EXCLUSIONS AND LIMITATIONS**

The warranties contained herein shall **NOT APPLY TO:**

- (1) Any defect which was caused (in Vermeer's sole judgment) by other than normal use and service of the Industrial Equipment, or by any of the following; (i) accident (ii) misuse or negligence (iii) overloading (iv) lack of reasonable and proper maintenance (v) improper repair or installation (vi) unsuitable storage (vii) non-Vermeer approved alteration or modification (viii) natural calamities (ix) vandalism (x) parts or accessories installed on Industrial Equipment which were not manufactured or installed by Vermeer authorized dealers (xi) the elements (xii) collision or other accident.
- (2) Any Industrial Equipment whose identification numbers or marks have been altered or removed or whose hourmeter has been altered or tampered with.
- (3) Any Industrial Equipment which any of the required or recommended periodic inspection or services have been performed using parts not manufactured or supplied by Vermeer or meeting Vermeer Specifications including, but without limitation, engine tune-up parts, engine oil filters, air filters, hydraulic oil filters, and fuel filters.
- (4) New Industrial Equipment delivered to the retail purchaser in which the warranty registration has not been completed and returned to Vermeer within ten (10) days from the date of purchase.
- (5) Any defect which was caused (in Vermeer's sole judgment) by operation of the Industrial Equipment not abiding by standard operating procedures outlined in the Operator's Manual.
- (6) Engine, battery, and tire Limited Warranties and support are the responsibility of the respective product's manufacturer.
- (7) Transportation costs, if any, of transporting to the Vermeer dealer. Freight costs, if any, of transporting replacement parts to the Vermeer dealer.
- (8) The travel time of the Vermeer dealer's service personnel to make a repair on the retail purchaser's site or other location.
- (9) In no event shall Vermeer's liability exceed the purchase price of the product,
- (10) Vermeer shall not be liable to any person under any circumstances for any incidental or consequential damages (including but not limited to, loss of profits, out of service time) occurring for any reason at any time.
- (11) Diagnostic and overtime labor premiums are not covered under this Limited Warranty Policy. Oils and fluids are not covered under this Limited Warranty.

- (12) Depreciation damage caused by normal wear, lack of reasonable and proper maintenance, failure to follow operating instructions, misuse, lack of proper protection during storage.
- (13) Accessory systems and electronics not of Vermeer's manufacture are warranted only to the extent of such manufacturer's respective Limited Warranty if any.
- (14) Downhole toolage is not covered under this warranty.
- (15) Wear items which are listed by product group as follows:

**ENVIRONMENTAL:** Bearing Seals, Bearings, Belts, Brake Pads, Bolts/Torqued Parts, Chain, Clutches, Clutch Components, Curtains, Cutter Wheels, Discharge Conveyor Belts, Fuel Filters, Hammers, Hoses, Infeed Conveyor Belts, Infeed Conveyor Chains, Knives, Oil Filters, Pockets, Rods, Rollers, Rotor Plates, Screens, Service Items, Shear Bar/Bedknife, Sprockets, Teeth, Wear Blocks, Wear Strips.

**TRACK:** Base Plates, Boom Wear Items, Buckets, Cable Fingers, Conveyor Belts, Clutches, Cups, Digging Chain, Digging Rims, Drums, End Idler, Flashings, Pins and Bushings, Pivot Rings, Plastic Wear Strips, Rooter Bands, Scraper Knives, Sprockets, Teeth, Track Chain, Track Rollers, Trench Cleaner (Crumber), Trip Cleaners, Truck Rollers, Wear Plates.

**TRENCHLESS:** Brushes, Clamping Vise Parts, Dies, Drive Chuck, Earth Stakes, Fan Belts, Jaws, Leaf Chain, Lights On Light Kits, Packing Assemblies, Rod, Rod Loader Parts, Rollers, Tooling, Track Chain, Track Guides, Track Idlers, Track Pads, Track Sprockets, Valve Seats, Wear Bars, Wear Blocks, Water Hoses, Water Swivels, Wear Bars.

**UTILITY PRODUCTS:** Augers, Belts, Bearings, Booms, Brake Pads, Bucket, Bushings, Chains, Clutches, Conveyor Belts, End Rollers, Flashings, Pins, Pivot Rings, Plow Blades, Rubber Shielding, Sprockets, Teeth, Tires, Track Chain, Track Idlers, Track Sprockets, Trench Cleaner (Crumber).

**PARTS WARRANTY:**

Parts replaced in the warranty period will receive the balance of the first year New Industrial Equipment Limited Warranty, during the first (12) months or 1000 hours, whichever comes first. Replacement parts after the original machine warranty, are warranted to be free from defects of material for ninety (90) days or the part will be repaired or replaced, without labor coverage for removal and reinstallation.

**EXCLUSIONS OF WARRANTIES: EXCEPT FOR THE WARRANTIES EXPRESSLY AND SPECIFICALLY MADE HEREIN, VERMEER MAKES NO OTHER WARRANTIES, AND ANY POSSIBLE LIABILITY OF VERMEER HEREINUNDER IS IN LIEU OF ALL OTHER WARRANTIES, EXPRESS, IMPLIED, OR STATUTORY, INCLUDING, BUT NOT LIMITED TO, ANY WARRANTIES OF MERCHANTABILITY OR FITNESS FOR A PARTICULAR PURPOSE. VERMEER RESERVES THE RIGHT TO MODIFY, ALTER AND IMPROVE ANY PRODUCT WITHOUT INCURRING ANY OBLIGATION TO REPLACE ANY PRODUCT PREVIOUSLY SOLD WITH SUCH MODIFICATION. NO PERSON IS AUTHORIZED TO GIVE ANY OTHER WARRANTY, OR TO ASSUME ANY ADDITIONAL OBLIGATION ON VERMEER'S BEHALF.**

**NO DEALER WARRANTY.** The selling dealer makes no warranty of its own and the dealer has no authority to make any representation or promise on behalf of Vermeer or to modify the terms or limitations of this warranty in any way.

**MANUFACTURED BY:  
VERMEER CORPORATION  
Pella, Iowa 50219 USA**

Provided for Free by Trenchwell.com  
Shop Aftermarket Parts

This page intentionally left blank.

# Receiving and Delivery Report

## DEALER PREP

Check or perform the following:

### General

- Check for shipping damage or shortage.
- Check that Operator's Manual is cabled to the machine.
- Check shield installation and condition.
- Check machine and attachment lubrication.
- Check bolts for tightness.
- Check machine lubrication.
- Check condition of all safety signs and operating decals.
- Check that all optional and loose items are included with the machine.
- Check that machine has proper counterweights for attachments.
- Check that seat belt is installed.
- Check Neutral Start and Operator Presence system operation.
- Check park brake adjustment and operation.

- \_\_\_ Check tire pressure: 8-ply, 26 x 12 - 12" - 50 psi (3.5 bar)
- \_\_\_ Check wheel lug nut torque: 260 ft-lb (352.5 Nm)
- \_\_\_ Check instrument and operating lights.
- \_\_\_ Check all phases of operation.
- \_\_\_ Complete "Dealer/Customer Information," *page v*.
- \_\_\_ Complete "Identification Numbers - Record," *page vi*.

### **Engine and Drivetrain**

- \_\_\_ Check battery electrolyte level and battery charge.
- \_\_\_ Check engine fan belt tension.
- \_\_\_ Check air cleaner condition and connections.
- \_\_\_ Check engine oil level.
- \_\_\_ Check engine operation.
- \_\_\_ Check axle differential oil level.
- \_\_\_ Check axle planetary oil level.
- \_\_\_ Check gearbox oil level.

### Hydraulics

- Check hydraulic oil level.
- Check the hydraulic components for leaks or damage.
- Check hydraulic controls for proper function.

### Backhoe

- Check that backhoe is securely mounted.
- Check that boom lift and swing locks function.
- Check that backhoe control levers are positioned under or on far side of handrail.
- Remote creep (option) adjusted for a maximum of 25 fpm (7.5 m/min)
- Remote emergency shutdown (option) shuts off engine

### Trencher

- Check that trencher is securely mounted.
- Check digging chain for proper tension and that chain does not turn with attachment drive control in NEUTRAL.
- Check installation, condition, and adjustment of trench cleaner assembly or restraint bar.
- Check that cutters are securely mounted.

## Plow

- Check that shaker gearcase is properly filled with oil.

## Reel Carrier

- Check that reel carrier is securely mounted.

## DELIVERY

Check and perform the following with customer:

- Review all sections of the *Operator's Manual*.
- Grease or oil all lubrication points; review lubrication decal and maintenance intervals.
- Ensure all requested options are installed.

Review and demonstrate with customer:

- overall explanation of how tractor works
- overall explanation of how attachments work
- tractor and attachment safety
- preparing tractor and attachments for operation

**DEALER/CUSTOMER INFORMATION**

dealer	owner
address	address
city	city
state / province	state / province
zip / postal code	zip / postal code
country	country

## IDENTIFICATION NUMBERS - RECORD

### Tractor

Model Number \_\_\_\_\_

Serial Number \_\_\_\_\_

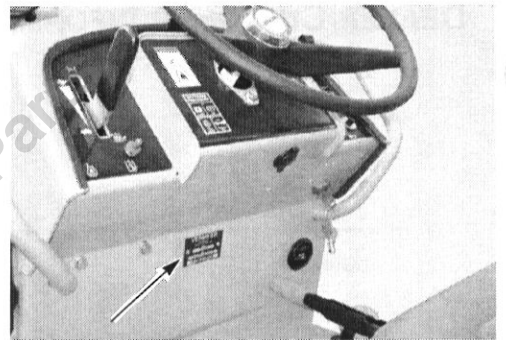

### Engine Identification

Model Number \_\_\_\_\_

Serial Number \_\_\_\_\_

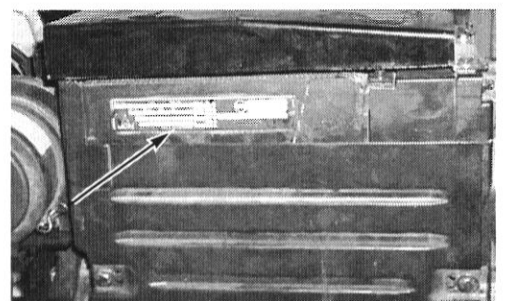

**Backhoe**

Model Number \_\_\_\_\_

Serial Number \_\_\_\_\_

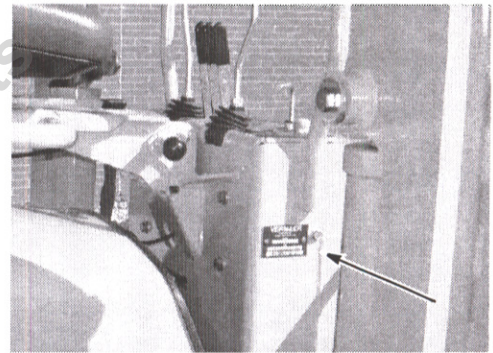

**Trencher, Sliding Offset Trencher**

Model Number \_\_\_\_\_

Serial Number \_\_\_\_\_

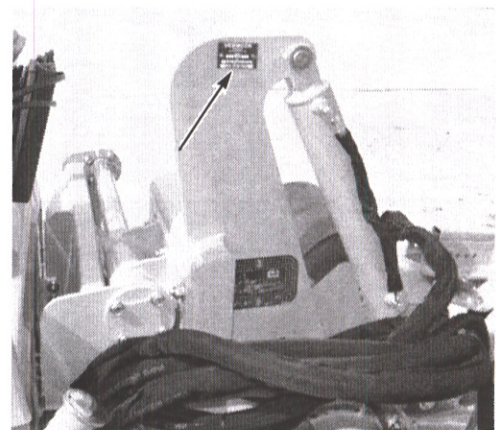

**Plow**

Model Number \_\_\_\_\_

Serial Number \_\_\_\_\_

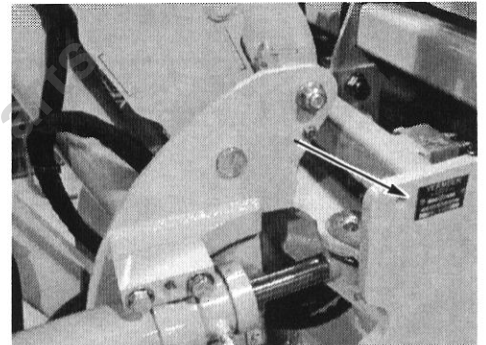

**Porta Bore**

Model Number \_\_\_\_\_

Serial Number \_\_\_\_\_

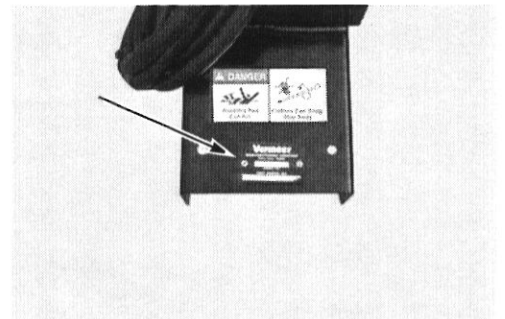

**Reel Carrier**

Model Number \_\_\_\_\_

Serial Number \_\_\_\_\_

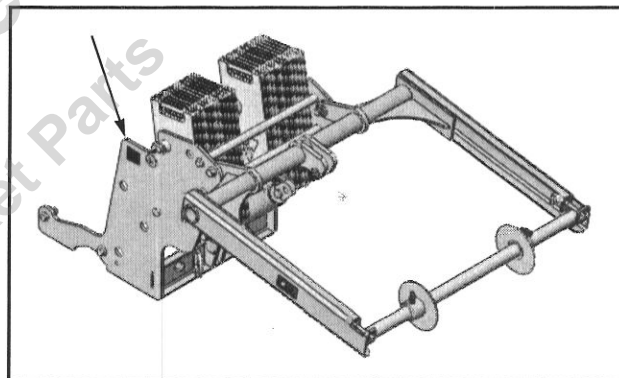

Provided for Free by Trenchwell.com  
Shop Aftermarket Parts

This page intentionally left blank.

## Table of Contents

<b>Receiving and Delivery Report</b> .....	<b>Tractor Controls</b> .....	<b>20-1</b>
Dealer Prep .....	Engine Controls .....	20-1
General .....	Indicators .....	20-3
Engine and Drivetrain .....	Ground Drive and Brake Controls .....	20-6
Hydraulics .....	Hydraulic Controls .....	20-8
Backhoe .....	Operator Presence Switch .....	20-9
Trencher .....	Seat Belt .....	20-9
Plow .....	Seat Adjustments .....	20-10
Reel Carrier .....	Fire Extinguisher Mounting Location .....	20-11
Delivery .....	Warning Beacon Mounting Location .....	20-11
Dealer/Customer Information .....		
Identification Numbers - Record .....	<b>Starting Procedure</b> .....	<b>22-1</b>
Tractor .....	Starting the Engine .....	22-2
Engine Identification .....	Cold Weather Starting .....	22-3
Backhoe .....	Ether Cold Starting System (Option) .....	22-3
Trencher, Sliding Offset Trencher .....	Hydraulic Bypass System .....	22-4
Plow .....	Jump-Starting .....	22-5
Porta Bore .....	Battery Explosion - Avoid .....	22-5
Reel Carrier .....	Battery Burns - Avoid .....	22-6
	Jump-Starting Procedure .....	22-6
<b>Counterweight Requirements</b> .....	<b>Shutdown Procedure</b> .....	<b>23-1</b>
<b>Safety Messages</b> .....	<b>Transporting the Machine</b> .....	<b>25-1</b>
Safety Symbol Explanation .....	Transportation Safety .....	25-1
	Mount and Dismount Safely .....	25-3
<b>Intended Use</b> .....	Driving the Machine .....	25-4

Trailing the Machine	25-5
Loading the Machine	25-5
Unloading the Machine	25-7
Towing the Machine	25-7
Retrieval	25-8
Lifting the Machine	25-8
<b>Preparing the Machine and Work Area</b>	<b>30-1</b>
Operator Qualifications	30-1
Operator Presence Switch - Check	30-1
Rollover Protective Structure (ROPS)	30-2
Seat Belt	30-3
Personal Protection	30-4
Sound and Vibration Levels	30-5
Prepare the Area	30-5
Locate Buried Utilities	30-6
Call Your One-Call System First	30-6
Look for Evidence of Underground Placement	30-7
Striking a Utility	30-7
Electricity	30-7
Gas	30-8
Fiber Optic	30-8
Jobsite Assessment	30-8
Prepare the Machine	30-10
<b>Backfill Blade</b>	<b>35-1</b>
Backfill Blade Controls	35-1
Backfill Blade Operation	35-3
Backfilling	35-4

<b>Backhoe</b>	<b>40-1</b>
Backhoe Controls	40-1
Backhoe Transport Locks	40-5
Engine Start and Stop	40-7
Seat Assembly	40-8
Operating the Backhoe	40-9
Backhoe Safety	40-9
Rollover Can Crush	40-10
No Riders in Backhoe Seat	40-11
Transporting	40-11
Backhoe Load Capacity - Model B450	40-12
Backhoe Operation	40-13
Dual Operation of Controls	40-13
Opening a Trench	40-14
Digging Procedure	40-15
Remote Creep (Option)	40-16
Finishing	40-16
<b>Trencher</b>	<b>45-1</b>
Trencher Controls	45-1
Trench Cleaner - Manual (Option)	45-3
Manual Fold	45-3
Operating the Trencher	45-3
Trencher Safety	45-3
Crystalline Silica	45-6
Trenching Tips	45-7
Chain Speed - Set	45-8
Digging Conditions	45-9
Trenching	45-10
Trench Cleaner Assembly (Option)/Restraint Bar	45-10

Starting the Trench . . . . .	45-11
Overriding Creep Lever . . . . .	45-14
Completing the Trench . . . . .	45-14
<b>Plow . . . . .</b>	<b>50-1</b>
Plow Controls . . . . .	50-1
Sod Cutter (Option) . . . . .	50-3
Plow Transport Lock . . . . .	50-3
Plow Blade - Install . . . . .	50-4
Without Hanger Holes . . . . .	50-4
With Hanger Holes . . . . .	50-5
Operating the Plow . . . . .	50-6
Plow Safety . . . . .	50-6
Plowing Tips . . . . .	50-6
Plowing - Start with Bell Hole or Trench . . . . .	50-7
Plowing - Start without Bell Hole or Trench . . . . .	50-8
Plowing - Continue . . . . .	50-9
Shaker Speed - Set . . . . .	50-10
Steering . . . . .	50-11
Offset Plowing Position . . . . .	50-12
Plowing - Stop with Bell Hole . . . . .	50-13
Plowing - Stop without Bell Hole . . . . .	50-13
<b>Porta Bore . . . . .</b>	<b>55-1</b>
Porta Bore Controls . . . . .	55-1
Porta Bore Operation . . . . .	55-1
Porta Bore Safety . . . . .	55-1
Drill Rod Safety . . . . .	55-2
Thrown Wrench . . . . .	55-2
Do Not Allow Drill Rod to Whip . . . . .	55-3

Work Area - Check/Clear . . . . .	55-3
Boring Attachment and Shield - Check . . . . .	55-4
Use Two People for Porta Bore Operation . . . . .	55-5
Shaft Angle - Limit . . . . .	55-5
Trench - Set Up . . . . .	55-5
Machine - Set Up for Boring . . . . .	55-6
Cutting Head - Guide . . . . .	55-7
Start Boring . . . . .	55-8
Operation - Check . . . . .	55-9
Drill Rod Grade - Check . . . . .	55-9
Motor Direction - Reverse . . . . .	55-9
Rod- Install Additional . . . . .	55-10
Universal Joint - Remove . . . . .	55-10
Guide Stakes . . . . .	55-10
Backreaming . . . . .	55-11
Cutting Tool - Change . . . . .	55-11
Water Jacket (Option) . . . . .	55-11
Reaming - Start . . . . .	55-12
Drill Rod - Remove . . . . .	55-12
Porta Bore Transport/Stow . . . . .	55-13
<b>Reel Carrier . . . . .</b>	<b>60-1</b>
Reel Carrier Controls . . . . .	60-1
Operating the Reel Carrier . . . . .	60-2
Reel Carrier Safety . . . . .	60-2
Machine Counterweights . . . . .	60-2
Carry Reels Only . . . . .	60-3
Reel Carrier - Hydraulic Attachment . . . . .	60-3
Load Reel . . . . .	60-4

<b>Maintenance Schedule</b> .....	<b>65-1</b>
Safety Signs .....	65-1
Maintenance Manual .....	65-2
Machine - Grease .....	65-2
Hourmeter - Check for Maintenance Interval .....	65-2
Maintenance Intervals .....	65-3

Provided for Free by Trenchwell.com  
 Shop Aftermarket Parts

## Section 5: Counterweight Requirements

RT450 Tractor Equipped with:	Counterweight Requirements
VPX455 Plow	1500-lb front weight kit, P/N RT450124 or 1800-lb front weight kit, P/N RT450125
VPX455 Plow with B450 Backhoe	50-lb wheel weights recommended on each front tire, P/N RT450112 Soft foam recommended in each front tire, P/N RT450056
VPX455 Plow with RC450 Reel Carrier	No counterweights required.
TR455 Center Mount Trencher (48" boom)	850-lb front weight kit, P/N RT450121
TR455 Center Mount Trencher (60" boom)	930-lb front weight kit, P/N RT450123
TR455 Center Mount Trencher with B450 Backhoe	No counterweights required.
SO455 Sliding Offset Trencher (48" boom)	930-lb front weight kit, P/N RT450123
SO455 Sliding Offset Trencher (60" boom)	1500-lb front weight kit, P/N RT450124
SO455 Sliding Offset Trencher with B450 Backhoe	No counterweights required.
<b>NOTE:</b> Counterweight chart assumes backfill blade as standard equipment unless noted.	
<b>NOTE:</b> Use only Vermeer approved attachments. Attachments may be available for this machine that are not included in this manual. Contact your Vermeer dealer for information.	

Provided for Free by Trenchwell.com  
Shop Aftermarket Parts

This page intentionally left blank.

© 2011 Trenchwell.com

## Section 10: Safety Messages

General safety messages appear in this Safety Messages section. Specific safety messages are located in appropriate sections of the manual where a potential hazard may occur if the instructions or procedures are not followed.

A signal word “**DANGER**”, “**WARNING**”, or “**CAUTION**” is used with the safety alert symbol.

Safety signs with signal word “**DANGER**”, “**WARNING**”, or “**CAUTION**” are located near specific hazards.

<b>DANGER</b>	Indicates a hazardous situation which, if not avoided, will result in death or serious injury.
<b>WARNING</b>	Indicates a hazardous situation which, if not avoided, could result in death or serious injury.
<b>CAUTION</b>	Indicates a hazardous situation which, if not avoided, could result in minor or moderate injury.

### SAFETY SYMBOL EXPLANATION



This is the safety alert symbol. This symbol is used in combination with an exclamation mark or other symbols to alert you to the potential for bodily injury or death.

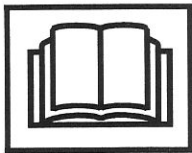

**WARNING:** Read Operator's Manual and safety signs before operating machine.

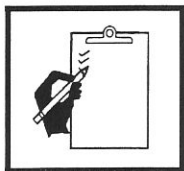

**WARNING:** Check machine before operating. Machine must be in good operating condition and all safety equipment installed and functioning properly.



**WARNING:** Wear required personal protective equipment. Dress properly. Avoid wearing jewelry such as rings, wristwatches, necklaces, or bracelets. Refer to "Personal Protection," page 30-4.



**WARNING:** Keep spectators away.



**WARNING:** Moving parts can crush.

Keep hands, feet, and clothing away from power-driven parts.

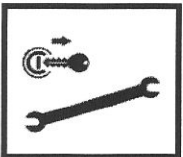

**WARNING:** Use Shutdown Procedure before servicing, cleaning, repairing, or transporting machine. Refer to *Shutdown Procedure*, page 23-1, for instructions.

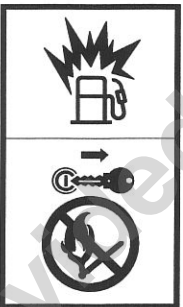

**WARNING:** Fuel and fumes can explode and burn.

Shut off engine before refueling. No flame. No smoking.



**WARNING:** Engine exhaust can asphyxiate. Operate only outdoors.



**WARNING:** Pressurized fluid can penetrate body tissue and result in serious injury or death. Leaks can be invisible. Keep away from any suspected leak. Relieve pressure in the hydraulic system before searching for leaks, disconnecting hoses, or performing any other work on the system. If you must pressurize the system to find a suspected leak, use an object such as a piece of wood or cardboard rather than your hands. When loosening a fitting where some residual pressure may exist, slowly loosen the fitting until oil begins to leak. Wait for leaking to stop before disconnecting the fitting. Fluid injected under the skin must be removed immediately by a surgeon familiar with this type of injury.



---

**WARNING:** Failure to follow any of the preceding safety instructions or those that follow within this manual, could result in serious injury or death. This machine is to be used only for those purposes for which it was intended as explained in this Operator's Manual.

---

## Section 15: Intended Use

The RT450 is a self-propelled rubber tire machine which can be equipped with front and rear mounted attachments to perform various functions such as trenching, plowing, backhoeing, backfilling, and horizontal drilling.

Always use the machine in accordance with the instructions contained in this manual, safety signs on the machine, and other material provided by Vermeer Corporation.

Proper maintenance and repair are essential for safety and efficient machine operation. Do not use the machine if it is not in suitable operating condition.



## Section 20: Tractor Controls

### ENGINE CONTROLS

(1) **Ignition Switch**.....

Vertical..... engine and electrical system OFF

First position clockwise..... engine and electrical system ON

Second position clockwise..... starts engine  
**NOTE:** Release key immediately after engine starts.

(2) **Throttle Lever**.....

 Push up..... increase engine speed

 Pull down..... decrease engine speed

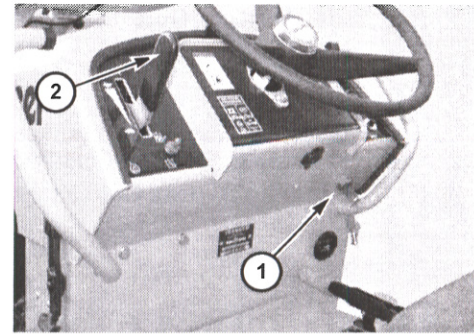
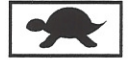
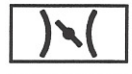

**(3) Horn Button**



Press button ..... sound horn.

**(4) Ether Button (Option)**



Push button once while cranking when initially starting engine in cold weather. Refer to "Cold Weather Starting," page 22-3.

**(5) Hydraulic Bypass Cold Start Switch (Option)**



Push up; hold. .... bypass ON



Diverts part of oil flow to tank, allowing engine to turn over faster.

Release switch. .... bypass OFF



Returns oil flow to normal.

Refer to "Hydraulic Bypass System," page 22-4, for additional information.

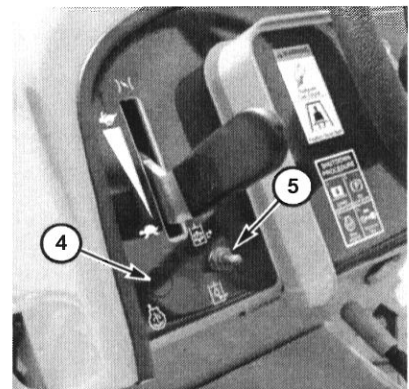
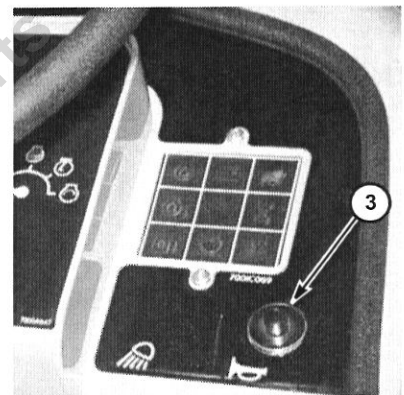

## INDICATORS

**NOTE:** Red lights flash when lit. If any of the lights (1), (2), or (3) come on during operation and stay on for 30 seconds, the machine will shut down.

### (1) Low Oil Pressure Warning Light

On ..... oil pressure low  
If red light turns on when engine is running, or if light does not shut off within 15 seconds after starting engine, shut off engine and correct problem.



### (2) High Engine Oil Temperature Warning Light

On ..... engine oil hot  
If red light turns on during operation, reduce load immediately and run engine at reduced engine speed. If light does not go out within 15 seconds after reducing engine speed to idle, shut off engine. Check for blockage of air intake screen and shrouding or broken blower belt.



### (3) Hydraulic Temperature Indicator

Red light indicates hydraulic oil temperature is too high. Follow *Shutdown Procedure*, page 23-1. Ensure cooler is not blocked and that front grill is clean. If no problem is detected, check hydraulic tank level.

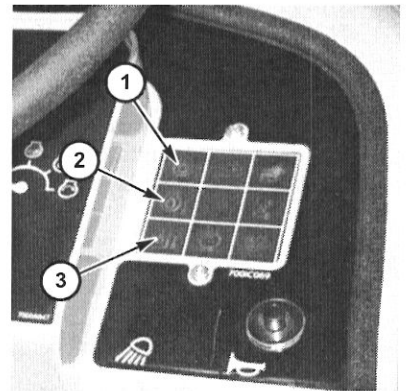

(4) **Low Alternator Output Warning Light**  
Red light on . . . . . alternator not charging



(5) **Operator Presence Indicator**  
On. . . . . operator seated and key is ON  
**NOTE:** Green light turns off when operator leaves seat  
**NOTE:** Engine will shut off in 5 seconds if light turns off when ground drive or rear attachment drive is engaged.



(6) **Ground Drive Neutral Indicator**  
Green indicator light turns ON when ground drive is in NEUTRAL.  
**NOTE:** Light must be ON to start engine.

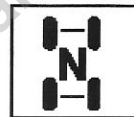

(7) **Rear Attachment Drive Neutral Indicator**  
Green indicator light turns ON when attachment drive is in NEUTRAL.  
Light must be ON to start engine.



(8) **Air Cleaner Restriction Indicator**  
Yellow light indicates that air cleaner requires service.

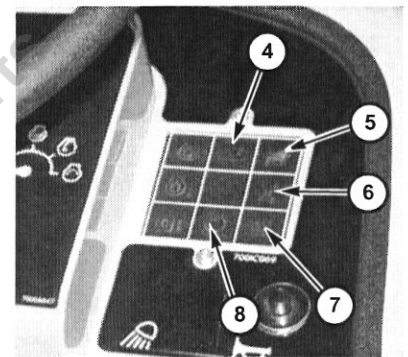

**(9) Light Switch (Option)**

Press top . . . . . both work lights and highway flashers on

Center . . . . . highway flashers on

Press bottom . . . . . all lights off

**(10) Hourmeter**

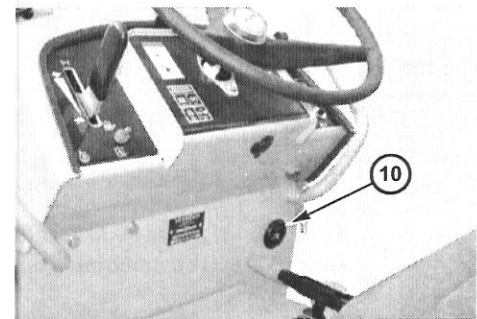
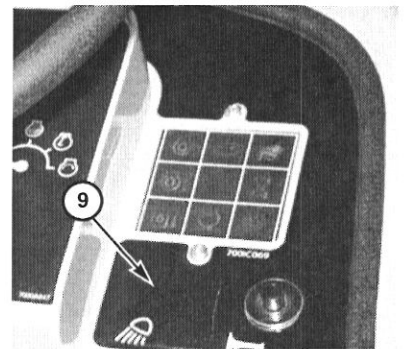

## GROUND DRIVE AND BRAKE CONTROLS

### (1) Park Brake



Pull back ..... engage

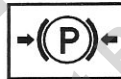

Push forward ..... disengage



**IMPORTANT:** The *Park Brake* is designed to hold the machine stationary when parked on a maximum 20% (11°) inclined slope per ISO 3450. This brake is not intended to be used to stop a fast-moving machine unless an emergency requires it.

### (2) Ground Drive Pedal/Service Brake



Forward ..... variable speed forward

Center ..... STOP



Back ..... variable speed reverse

The *Ground Drive Pedal* is also the *Service Brake*, which is used to slow or stop the machine from any travel speed.

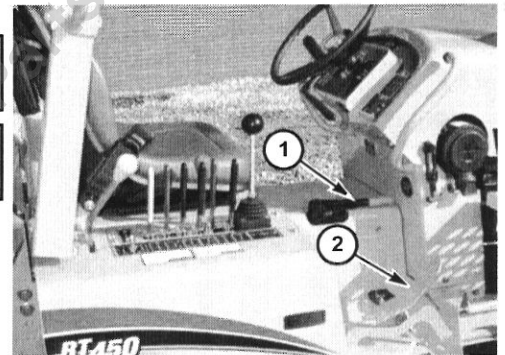

(3) **Creep Lever**



Push forward ..... variable speed forward

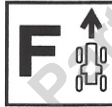

**NOTE:** *Ground Drive Pedal* overrides *Creep Lever*. When foot pedal is released, machine resumes operation at *Creep Lever* setting.

Center ..... STOP



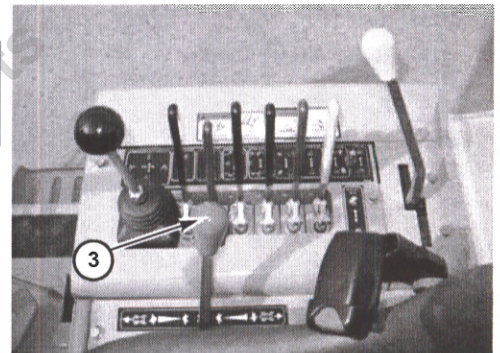

Pull back ..... variable speed reverse



## HYDRAULIC CONTROLS

### (1) Rear Steer Lever

 Push right . . . . . steer rear axle right

 Pull left . . . . . steer rear axle left

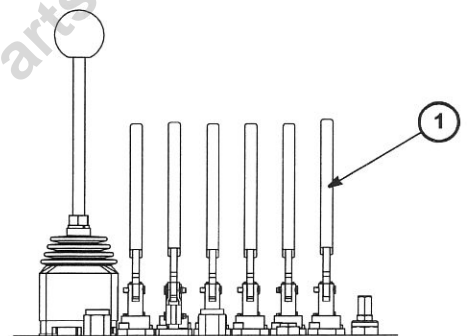

**NOTE:** Rear Steer available on 8-spool valve only.

## OPERATOR PRESENCE SWITCH

The Operator Presence system uses a switch in the operator seat to detect the presence of an operator. The operator must be seated for the ground drive or attachment drive to be engaged.

If the operator leaves the seat while the ground drive or attachment drive is engaged, the engine will stop within 5 seconds. The ground drive and attachment drive controls must be returned to NEUTRAL before the engine can be restarted.

The Operator Presence system is intended for your safety and must be maintained in good functional condition. Contact your Vermeer dealer if it does not function properly.

## SEAT BELT

Seat belt (1) must be worn at all times while operating machine from tractor controls. To fasten seat belt, extend belts and snap two ends together. Ensure all slack is out of belt. Seat belts must be snug but not tight.

To unfasten seat belt, press release on 2" belt.

**NOTE:** Some tractors have a 3" (7.5 cm) seat belt. If belt is too loose, pull end of belt extending from the buckle (2) until belt fits snugly. If belt needs to be lengthened, pull on the buckle as shown (3) and then follow the above procedure. To unfasten seat belt, lift release on the buckle as shown (4).

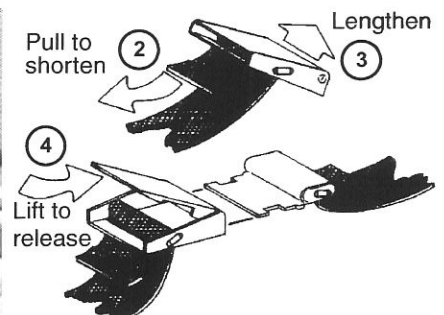
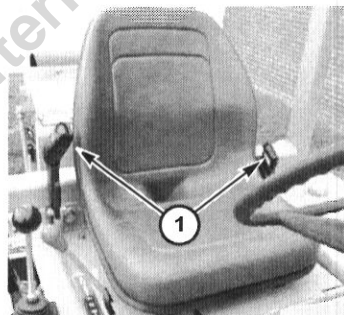

## Seat Adjustments

Push lever (1) to lift seat and mounting plate for access to hydraulic tank.

Always fasten cable (2) to steering wheel when seat is raised. Check that seat lever (1) latches when seat is lowered.

Push lever (3) to side to adjust seat position forward and backward.

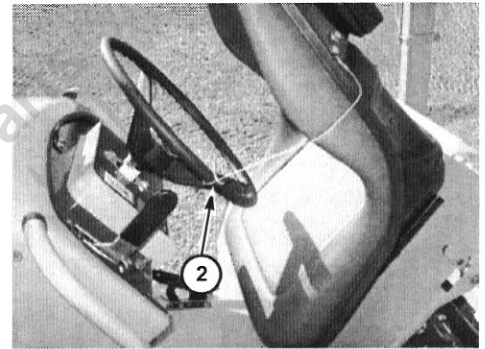
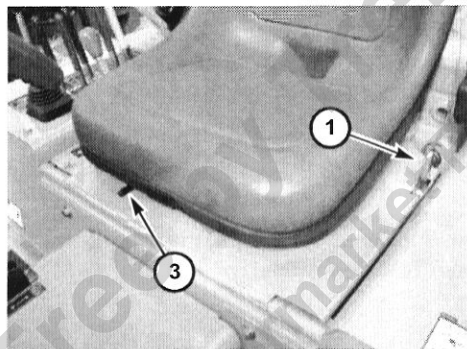

## FIRE EXTINGUISHER MOUNTING LOCATION

If a fire extinguisher is to be installed, mount fire extinguisher on back side of left post of ROPS roll bar (1). Do not drill or weld on the roll bar. Clamp the fire extinguisher bracket to the roll bar.

## WARNING BEACON MOUNTING LOCATION

If a warning beacon is to be installed, clamp beacon to top of ROPS roll bar (2). Do not drill or weld on roll bar.

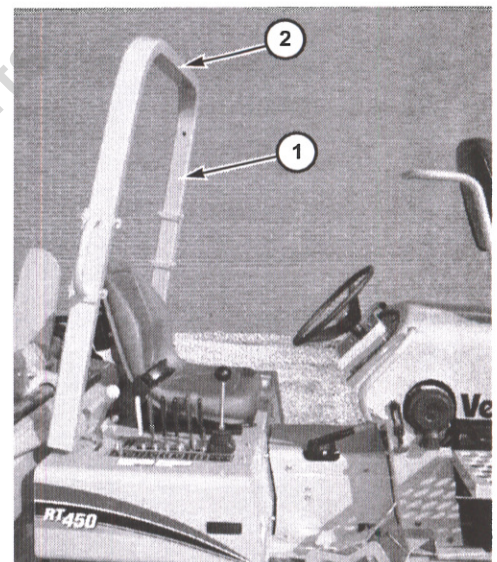

Provided for Free by Trenchwell.com  
Shop Aftermarket Parts

This page intentionally left blank.

## Section 22: Starting Procedure

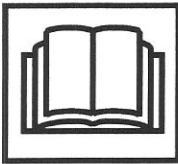

**WARNING:** Do not start or operate machine unless instructions in this manual have been carefully read and understood.



**WARNING:** Runover possible.

To avoid machine runaway, start engine only from operator's seat with *Park Brake* on and ground drive controls in NEUTRAL. Never start engine by shorting across starter terminals. Machine will move if ground drive is engaged.

## STARTING THE ENGINE

The operator must be seated at tractor controls, with seat belt fastened, when starting engine.

Step 1: Place *Attachment Drive* (1) and *Ground Drive* (2) in NEUTRAL.

Step 2: Apply *Park Brake* (3).

Step 3: Set *Throttle* (4) at 1/4 position.

**NOTE:** Starter will not engage if attachment and ground drive controls are not in NEUTRAL.

Step 4: Turn *Ignition Switch Key* (5) clockwise to start engine; release key, then set throttle to idle after engine starts.

**IMPORTANT:** Never run starter motor for more than 20 seconds at a time. Allow starter motor to cool one minute between attempts.

**IMPORTANT:** Shut off engine if oil pressure light does not go off within 15 seconds of starting.

- Do not exceed idle until engine oil pressure warning light is off. Increase RPM slowly to maintain oil pressure.
- Do not operate engine under load until engine has warmed up at least five minutes.
- Consult Engine Operation Manual for allowable idle speed and time periods.

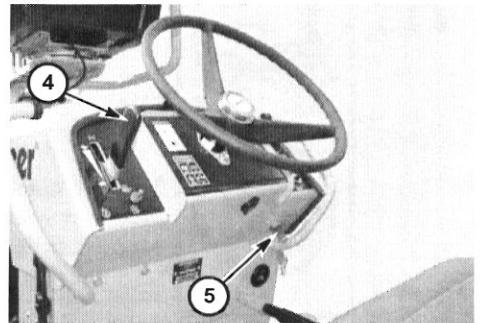
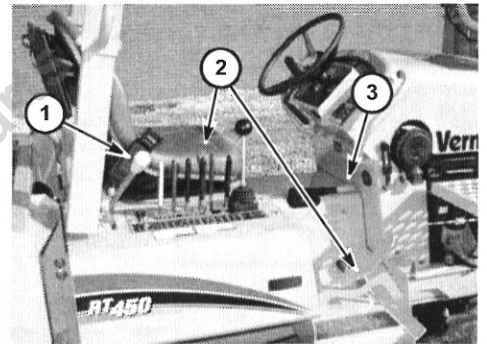

## COLD WEATHER STARTING

Allow adequate time for hydraulic oil to warm up, especially in cold weather.

When operating in cold weather, it is important to use recommended engine oil viscosity and fuel to reduce starting problems. Refer to the Engine Operation Manual.

## ETHER COLD STARTING SYSTEM (OPTION)



**WARNING:** Starting fluid is highly flammable and can explode. Keep container away from heat, sparks, and open flame. Do not puncture or incinerate container.

Use ether system below 32°F (0°C) and only if engine is cold.

Step 1: Remove cap from new cylinder (1) and install in valve (2). Turn until seated tightly against gasket and secure with hose clamp.

**IMPORTANT:** Keep starting fluid container in place to protect cold starting components.

Step 2: Move throttle lever to 1/4.

Step 3: While turning starter switch, push in and release ether button (3). Inject only one shot of ether per starting attempt.

Step 4: Return throttle to idle as soon as engine starts.

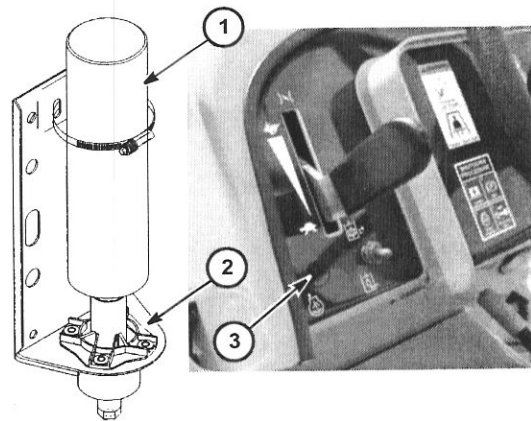

## HYDRAULIC BYPASS SYSTEM



**WARNING:** Releasing bypass switch enables hydraulic system. If hydraulic controls are not in NEUTRAL when bypass switch is released, unexpected movement of tractor attachments, or hydraulic cylinders can occur.

Use hydraulic bypass system for starting machine below 20°F (-7°C).

- Step 1: Hold bypass switch (1) in “bypass” position. Steering, implement and closed loop hydrostatic circuits are bypassed.
- Step 2: Start engine. Use ether system if equipped.
- Step 3: Allow engine idle to stabilize, then release bypass switch.

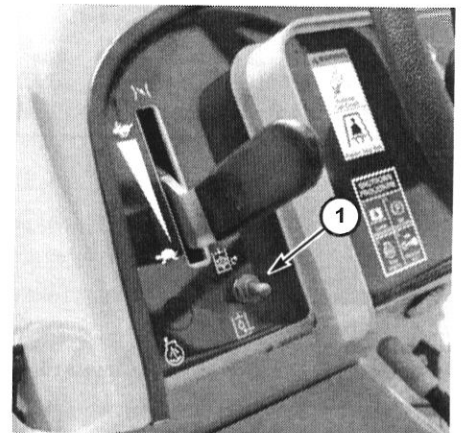

## JUMP-STARTING

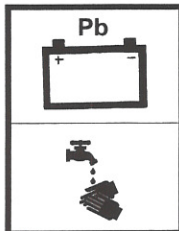

**WARNING:** Battery post, terminals, and related accessories contain lead and lead compounds, chemicals known to the state of California to cause cancer and reproductive harm.

Wash hands after handling.

## Battery Explosion - Avoid



**WARNING:** Battery fumes are flammable and can explode. Keep all burning materials away from battery. Battery explosion can blind. Acid can blind and burn. Tools and cable clamps can make sparks.

Do not smoke. Shield eyes and face. Read instructions.

Do not jump-start or charge a battery that is frozen or low on electrolyte.

Avoid explosion hazard. If equipped with battery caps, they must be in place and tight.

**IMPORTANT:** Use only a 12-volt system for jump-starting. Do not allow vehicle used to jump-start to be in contact with the disabled machine. Vehicles in contact have a ground connection which allows a spark to occur at the battery when the positive jumper cable is connected or removed.

## Battery Burns - Avoid

Battery contains sulfuric acid which can cause severe burns. Avoid contact with eyes, skin, and clothing.

In case of acid contact:

**External:** Flush with plenty of water. If eyes have been exposed, flush with water for 15 minutes and get prompt medical attention.

**Internal:** Drink large quantities of water or milk; follow with milk of magnesia, beaten egg, or vegetable oil. Call a physician immediately.

## Jump-Starting Procedure

Turn ignition key OFF.

Make jumper cable connections in following order:

- Step 1: Red to discharged battery POSITIVE (+) (1).
- Step 2: Red to boost battery POSITIVE (+) (2).
- Step 3: Black to boost battery NEGATIVE (-) (3).
- Step 4: Black to discharged machine frame (4) (away from battery, fuel lines, and moving parts). Do not attach to negative (-) terminal of discharged battery.

While seated at controls, start engine. Remove cables in REVERSE order and reinstall red covers over positive battery cable clamps.

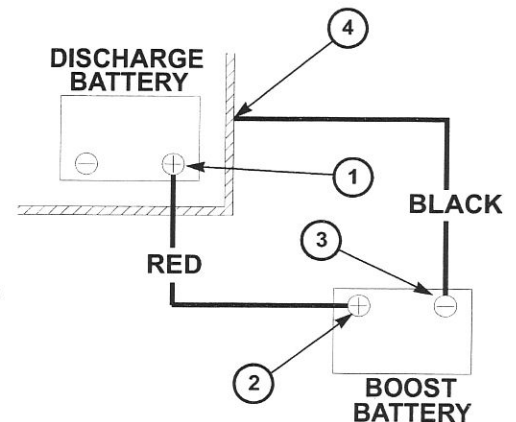

## Section 23: Shutdown Procedure

**IMPORTANT:** For your safety and the safety of others, use the shutdown procedure before working on the machine for any reason, including servicing, cleaning, unclogging, or inspecting the machine.

When stopping machine, use the following Shutdown Procedure:

Step 1: Place *Ground Drive Control* in NEUTRAL/STOP.

Step 2: Engage *Park Brake*.

**IMPORTANT:** The Park Brake is designed to hold the machine stationary when parked on a maximum 20% (11°) inclined slope per ISO 3450. This brake is not intended to be used to stop a fast-moving machine unless an emergency requires it.

Step 3: Disengage power to all attachments.

Step 4: Lower all attachments to the ground or engage transport locks.

Step 5: Reduce engine speed to idle.

Step 6: Shut off engine and remove key.

A variation of the above procedure may be used if instructed within this manual or if an emergency requires it.

Provided for Free by Trenchwell.com  
Shop Aftermarket Parts

This page intentionally left blank.

11/11/2016 10:00:00 AM

# Section 25: Transporting the Machine

## TRANSPORTATION SAFETY



**WARNING:** Falling off or contact with wheels can injure you. A rider can fall off and be crushed or run over.



No riders. Only the operator, seated with the seat belt fastened, may ride on the machine. Never allow anyone to ride on machine while moving the machine.

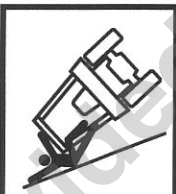

**WARNING:** Rollover possible. Serious injury or death can result if crushed under machine.



Always wear your seat belt. Never allow anyone to be on downhill side of machine. Be alert and use extreme caution when operating on hillsides, or near ditches, gullies, holes or obstructions where rollover could occur.



**WARNING:** Proper tractor stability requires an attachment on front and rear of tractor. Some attachment combinations require additional counterweighting. Refer to “Counterweight Requirements,” *page 5-1*.

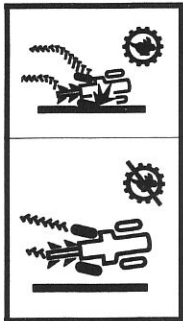

**WARNING:** Machine may move sideways quickly if rear steering is done at fast travel speeds. Operator or bystanders may be seriously injured or killed if struck by machine.

Use rear steering at slow speeds only.

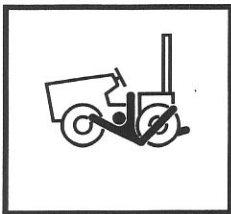

**WARNING:** Runover or crushing can kill or injure you.

When driving or operating the machine, be aware of the location of other people on the jobsite. Do not allow anyone, especially children, to approach the machine when moving from one work zone to another. Always look where the machine is going. Watch for other people. Stop the machine if anyone enters the machine work zone.

### Mount and Dismount Safely

- Face machine when mounting and dismounting. Rotate backhoe seat sideways for best visibility.
- Do not use any controls as handholds when climbing on or off machine.
- Never jump off machine.
- Never get on or off a moving machine.



## Driving the Machine

Raise and secure front and rear attachments in transport position. Rotate backhoe seat sideways for best visibility.

Use ground drive pedal to move machine. Do not use creep lever to move machine. The lever does not return to NEUTRAL automatically.



**WARNING:** Rear attachment in offset position reduces machine stability. Rollover may result in serious crushing injury or death. Never drive across slope with rear attachment shifted to downhill side. Center rear attachment before driving machine.

**IMPORTANT:** When driving on public roads, check on applicable laws concerning the use of lights, a slow-moving vehicle sign, and other possible requirements.

**IMPORTANT:** Before driving or operating machine, survey the area around the machine for persons or obstacles. Drive machine at a speed suitable for the terrain. Use slower ground speeds if you are inexperienced or driving on hillsides, uneven terrain, or near ditches, gullies, holes, or barriers. Avoid sudden stopping, starting, or turning unless necessary.

## TRAILERING THE MACHINE

### Loading the Machine



**WARNING:** Before transporting machine on a trailer, read trailer manual for safety precautions and information. Ensure trailer bed and ramps are clean and free of obstacles and debris that may interfere with loading process.

Ensure gross weight of machine with attachments is within gross weight limits of trailer and towing vehicle. Load machine on a level surface with trailer attached to towing vehicle.

**NOTE:** A Tractor/Attachments Weight chart is included in the Specifications Section of the *Maintenance Manual*. These weights can be used to determine the approximate gross weight of a vehicle configuration.



**WARNING:** Drive machine on and off trailer squarely to avoid driving off the side of trailer which may result in possible rollover.

- Step 1: Center machine on trailer centerline; drive squarely onto trailer.
- Step 2: Stop at tie-down position for correct weight distribution as recommended by trailer manufacturer.
- Step 3: Apply *Park Brake*, lower attachments to trailer bed, and shut down engine.
- Step 4: Fasten each corner of machine to trailer using tie-downs provided on machine.

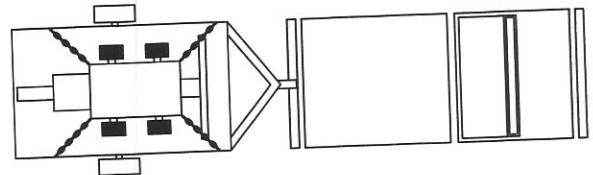

**NOTE:** Consult state and federal highway regulations for requirements on the proper securing of equipment.

**IMPORTANT:** If machine is equipped with backhoe, ensure stabilizer latches are engaged prior to trailering or long-term storage.

Raise stabilizers fully up to engage stabilizer latch (1).

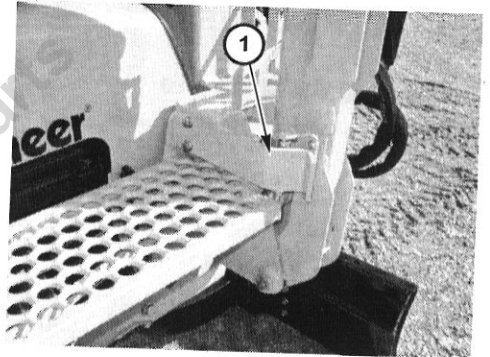

## Unloading the Machine

To unload machine, place trailer on a level surface.

- Step 1: Remove chains.
- Step 2: Start engine.
- Step 3: Raise attachments to transport position.
- Step 4: Release *Park Brake*.
- Step 5: Use *Ground Drive Pedal* and slowly unload machine from trailer.

## TOWING THE MACHINE

Towing requires bypassing the ground drive pump. Remove pump cover, then unscrew the bypass valve (1) a maximum of 2 turns. This valve allows the motor to turn.

The ground speed of the machine must not exceed 1–2 mph (2–3 km/h). Higher speeds will cause heat buildup which will damage the pump and motor.

**IMPORTANT:** This valve must be fully closed for normal tractor operation. Torque bypass valve to 7–10 ft-lb (10–14 Nm).

Do not attempt to push-start the machine. Damage to ground drive pump or motor will result if towing instructions are not followed correctly.

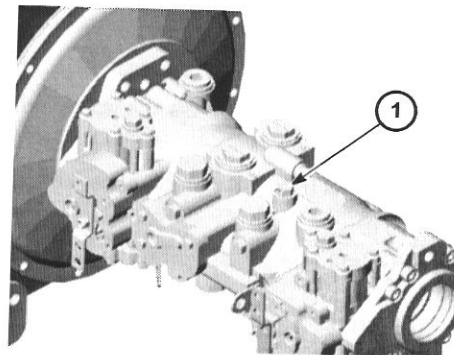

## RETRIEVAL

The following procedures are intended to be used when towing a machine which has become mired or disabled.

Connect tow chain/cable to each side of rear axle.

If machine can only be accessed from front, attach tow chain/cable to backfill blade as follows:

Step 1: With backfill blade in transport position, loop chain over top of both lift frame arms (1).

**NOTE:** Ensure chain does not contact backfill blade cylinders.

Step 2: Guide chain under backfill blade (2) and attach to suitable towing vehicle.

**IMPORTANT:** Bypass the ground drive pump before retrieval. See "Towing the Machine," page 25-7 for instructions.

**IMPORTANT:** Towing device (chain, cable, or strap) must have a minimum working load of 150% of **towing** machine weight.

Do not exceed 1–2 mph (2–3 km/h) when towing.

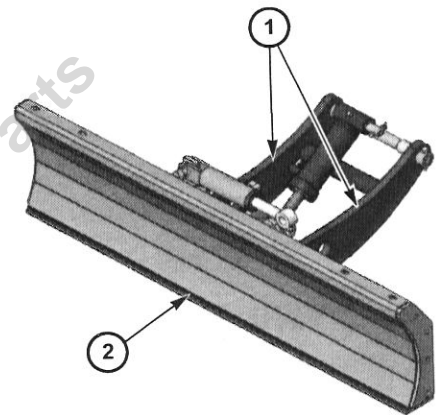

## LIFTING THE MACHINE

No provisions are made for lifting the machine. If transport requires that machine be lifted, it must be loaded in an appropriate container.

## Section 30: Preparing the Machine and Work Area

### OPERATOR QUALIFICATIONS



**WARNING:** Read Operator's Manual and safety signs before operating machine.

Allow only responsible, properly instructed individuals to operate machine.

Become familiar with the controls, operation, and use of the machine under the supervision of a trained and experienced operator.

The operator must be familiar with the workplace's safety rules and regulations, and must be mentally and physically capable of operating the machine safely.

### OPERATOR PRESENCE SWITCH - CHECK

The Operator Presence system uses a switch in the operator seat to detect the presence of an operator. The operator must be seated for the ground drive or attachment drive to be engaged.

If the operator leaves the seat while the ground drive or attachment drive is engaged, the engine will stop within 5 seconds. The ground drive and attachment drive controls must be returned to NEUTRAL before the engine can be restarted.

The Operator Presence system is intended for your safety and must be maintained in good functional condition. Contact your Vermeer dealer if it does not function properly.

## ROLLOVER PROTECTIVE STRUCTURE (ROPS)

1. Do not operate machine with ROPS removed.
2. Do not modify ROPS in any manner. Unauthorized modifications, such as welding, drilling, cutting, or adding attachments, could weaken the structure and reduce your protection.
3. If ROPS has been damaged or subjected to a rollover, it must be replaced. Do not attempt any repairs.
4. The ROPS has been certified to a maximum gross machine weight as stated on the label located on the ROPS. Under no circumstances may total gross weight of machine exceed weight specified on ROPS label.
5. If ROPS must be replaced, be sure to use original parts ordered from Vermeer Corporation.

If rollover occurs:

- Brace yourself and stay on the machine. **Keep seat belt fastened.**
- Hold on firmly and lean away from the point of impact.

## SEAT BELT

**IMPORTANT:** Seat belts must be worn at all times while the machine is operating.

The seat belt is an essential part of the Rollover Protection system. It helps keep you in the protected area inside the rollover protective structure. Inspect seat belt every time it is used, looking for cuts or worn webbing, or any defect in the latch assembly. If any wear or damage is noted, do not operate the machine until the seat belt is replaced.

If it is necessary to clean belts, use a mild soap solution and lukewarm water. Do not use bleach, dye, solvents, or other chemicals which may weaken the belts.

To fasten Automatic Locking Retractor Seat Belts:

- Step 1: Pull latch steadily until it reaches the buckle.
- Step 2: Put latch into buckle until positive snap is heard.
- Step 3: Ensure there are no twists in the seat belt webbing.
- Step 4: Allow retractor to take up any slack in the webbing.
- Step 5: Give a sharp pull on the webbing to ensure retractor is locked.

**NOTE:** Wear seat belt low and snug.

- Step 6: If retractor locks before the latch reaches the buckle, allow webbing to be fully retracted and repeat the steps above.

## PERSONAL PROTECTION



**WARNING:** Wear personal protective equipment. Wear close-fitting clothing and confine long hair. Avoid jewelry, such as rings, wristwatches, necklaces, or bracelets.

Operating the machine will require you to wear protective equipment. You should always wear a hard hat, safety shoes, and eye protection. If working near traffic, you may have to wear reflective clothing.

Hearing protection is required when operating machine. Hearing protection devices provide differing levels of sound reduction. It is important to select a device that is adequate and appropriate for your specific work environment. Actual sound levels may vary widely, depending on your working conditions. To determine the level of hearing protection your work environment requires, enlist the help of your local environmental noise specialist.

Eye protection must consist of wraparound safety glasses or goggles.

Other workers in the immediate area must also wear hard hats, safety shoes, and eye protection.

To reduce the risk of being caught and entangled in moving components, wear close-fitting clothing and confine long hair. Avoid wearing jewelry, such as rings, wristwatches, necklaces or bracelets.

## SOUND AND VIBRATION LEVELS

Sound pressure and sound power levels were determined according to test procedures specified in ISO 3744 and ISO 6394.

Equivalent Continuous A-Weighted Sound Pressure	
at Operator's Ear .....	90 dB(A)
at backhoe station .....	89 dB(A)
Guaranteed Sound Power Level as determined by	
EU Directive 2000/14/EC .....	105 dB(A)
Whole Body Vibration according to ISO 2631-1 .....	less than * m/sec <sup>2</sup>

**NOTE:** The stated sound levels are representative for a given operating condition. Operating conditions may vary at each jobsite. The actual sound levels for your application and operating conditions may be different.

\*Information not available at time of printing.



## PREPARE THE AREA

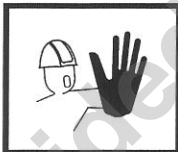

**WARNING:** Keep all spectators and other workers away from the machine and work area while in operation.

## LOCATE BURIED UTILITIES

### Call Your One-Call System First



**WARNING:** Electricity or gas explosion can kill. Laser light in cut cable can cause eye damage.

Locate utilities before digging. Call 811 or 1-888-258-0808 (U.S. or Canada) or local utility companies or national regulating authority.

Before you start any digging project, do not forget to call the local One-Call system in your area and any utility company that does not subscribe to the One-Call system. For areas not represented by One-Call Systems International, contact the appropriate utility companies or national regulating authority to locate and mark underground installations. If you do not call, you may have an accident or suffer injuries; cause interruption of services; damage the environment; or, experience job delays.

The One-Call representative will notify participating utility companies of your proposed digging activities. Utilities will then mark their underground facilities by using the following international marking codes:

Red	Electric	Green/Brown	Sewer
Yellow	Gas, Oil or Petroleum	White	Proposed Excavation
Orange	Communication, Telephone, TV	Pink	Surveying
Blue	Potable Water		

**OSHA CFR 29 1926.651** requires that the estimated location of underground utilities be determined before beginning excavation or underground drilling operation. When the actual excavation or bore approaches an estimated utility location, the exact location of the underground installation must be determined by a safe, acceptable and dependable method. If the utility cannot be precisely located, it must be shut off by the utility company.

### Look for Evidence of Underground Placement

Visually check for:

- notices of underground placements
- manhole covers
- drop boxes
- recent trenching activity

### Striking a Utility

#### Electricity



**DANGER:** Electricity or gas explosion can kill. Laser light in cut cable can cause eye damage. Locate utilities before digging. Call 1-888-258-0808 (U.S. or Canada) or local utility companies or national regulating authority.

Some circuit breakers automatically reset. Do not assume power has been permanently disconnected until you **confirm that the utility company has locked out power to that line.**

## Gas



**DANGER:** Electric shock can kill.

If a strike occurs, release all contact with machine. Have someone who is clear of the area contact the utility company to shut off electrical power. Do not allow anyone to approach the machine.

If you strike a gas line, shut off engine and evacuate area immediately. Contact utility company and do not return until the utility company gives permission to do so.

## Fiber Optic

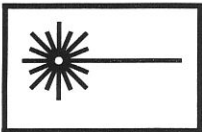

**WARNING:** Fiber optic cables carry laser light which may damage your eyes. Do not look into the end. If you are not sure what kind of cable it is, do not look into the end. Contact appropriate utility company for assistance.

Contact appropriate utility company for assistance.

## Jobsite Assessment

Examine work area for any obstructions, conditions, or situations which may impair machine operation or create a safety hazard for the operator or other persons. Use information in this manual combined with your own good judgment when identifying these hazards and implementing hazard avoidance measures.

Check for banks, overhangs, drop-offs, and trenches.



**WARNING:** The weight of your machine may cause the ground to give way. Machine can fall and tip over. Death or serious injury could result. Keep well away from cliff edges. Do not dig under the machine or blade. Take care when backfilling. Do not go too close to edges.

When work is planned inside or around structures such as buildings, bridges, and low-hanging tree limbs, check for adequate overhead and side clearances. Be sure to account for the height of the boom.



**WARNING:** Engine exhaust can asphyxiate. If inhaled directly or continuously, the combustion fumes produced by the engine can be very dangerous and/or lethal for the human body. If work has to be done in enclosed environments, take all necessary precautions to ensure the circulation of fresh air and protect the respiratory tract using a suitable mask.

Good ventilation is very important. Sparks from the electrical system and engine exhaust can cause an explosion or fire in a flammable or explosive atmosphere. Do not operate this machine in an area with flammable dust or vapors.

Carbon monoxide fumes from the engine can asphyxiate. Operate only outdoors or provide adequate ventilation if indoor operation is essential.

## PREPARE THE MACHINE

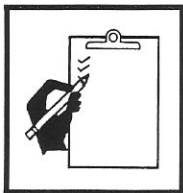

**WARNING:** Check machine before operating. Machine must be in good operating condition and all safety equipment installed and functioning properly.











- Ensure you understand and comply with all jobsite rules that might apply to your work situation.
- Adjust seat for best access to controls.
- If operating along a road, properly warn and divert motor and pedestrian traffic. Use all necessary signs, cones, flag persons, or lighting devices needed for the work situation.

**IMPORTANT:** Machine controls and electrical/electronic devices are not rated to withstand high pressure water and temperature power washers. Water intrusion will likely cause malfunction or damage to any devices hit directly by the water spray. Keep pressure washer stream away from machine controls and electrical/electronic devices. Compressed air can also push moisture through some connector and component seals. Do not point air nozzle directly at seal areas.

# Section 35: Backfill Blade

## BACKFILL BLADE CONTROLS

### (1) Blade Lift/Swing Joystick

	Push forward .....	lower	
	Push forward to detent .....	float	
	Pull back .....	raise	
	Push right .....	swing blade right	
	Pull left .....	swing blade left	

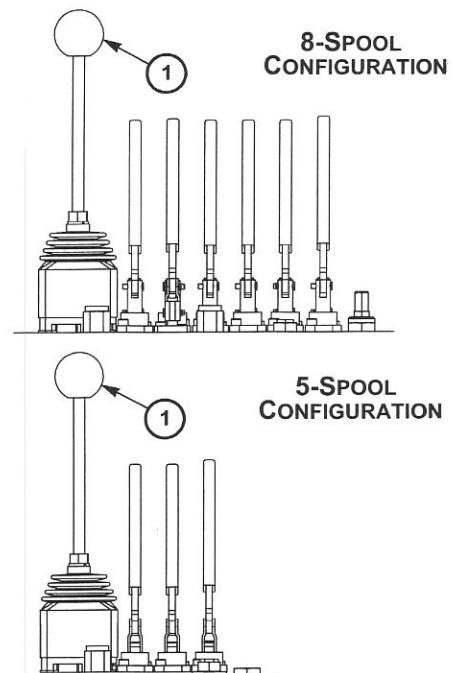

Provided for Free by Trenchwell.com  
Shop Aftermarket Parts

(2) **Blade Tilt Lever**

 Push right ..... tilt right side down

 Pull left ..... tilt left side down

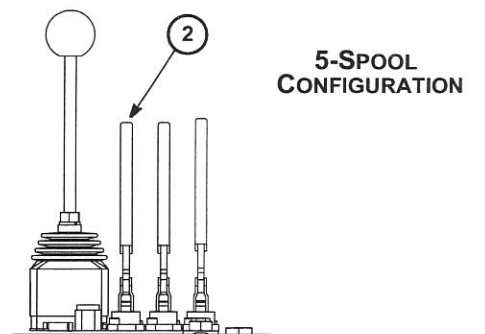
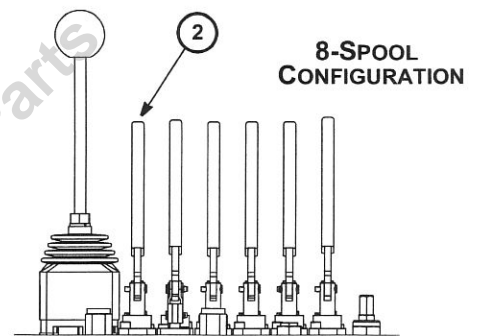

## BACKFILL BLADE OPERATION



**WARNING:** Before attempting to operate machine, refer again to "Safety Messages," *page 10-1*, for important information.

---

Familiarize yourself with location and function of the tractor controls and the backfill blade controls before operating. Refer to "Tractor Controls," *page 20-1*, and "Backfill Blade Controls," *page 35-1*.

## Backfilling

Step 1: Use *Ground Drive Pedal* to move machine for backfilling.

Do not use *Creep Lever* to backfill. Creep controls do not return to NEUTRAL automatically.

Step 2: Lower and tilt backfill blade to match contour of ground.

Step 3: Angle/swing backfill blade toward trench to be filled.

**IMPORTANT:** To prevent possible damage to blade when changing angle, raise blade enough to remove contact with the ground.

Step 4: When moving spoil into trench, do not fill blade to full capacity. Make more than one pass at spoil pile.

**NOTE:** If engine begins to stall while pushing spoil, reduce amount of spoil being pushed by raising blade or moving more to outside of spoil pile.

Step 5: Once trench is filled, drive with wheels on filled trench to compact soil.

Step 6: For final dress, drag blade in reverse with blade lift control set in FLOAT position.

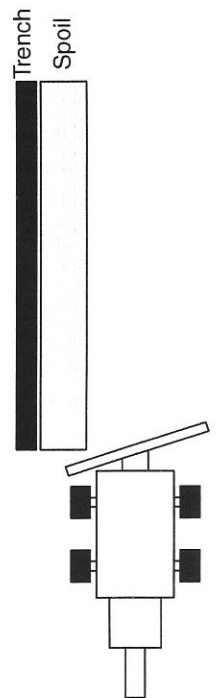

# Section 40: Backhoe

## BACKHOE CONTROLS

### (1) Left Stabilizer Lever

 Push forward..... lower left stabilizer

 Pull back..... raise left stabilizer



### (2) Backfill Blade Control Lever

 Push forward..... lower backfill blade

 Pull back..... raise backfill blade



### (3) Right Stabilizer Lever



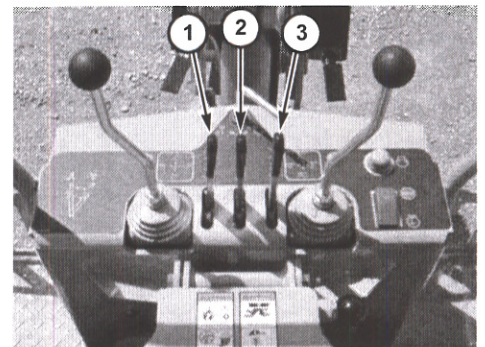

 Push forward..... lower right stabilizer

 Pull back..... raise right stabilizer



**(4) Boom Lift/Boom Swing Joystick**

**NOTE:** This is a multiple-direction, dual-control joystick.

-  Push forward..... lower boom
-  Pull back ..... raise boom
-  Push left ..... swing boom left
-  Push right ..... swing boom right

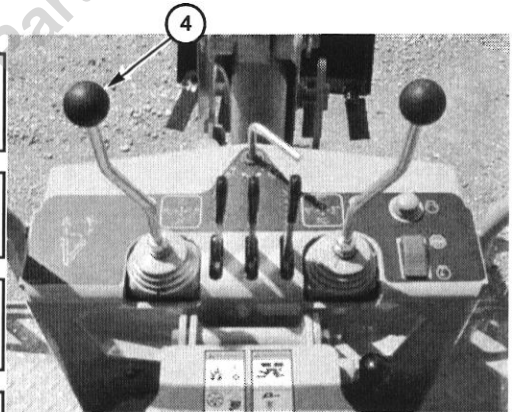

**(5) Boom Dipperstick/Bucket Joystick**

**NOTE:** This is a multiple-direction, dual-control joystick.



Push forward ..... extend dipperstick



Pull back ..... fold dipperstick



Push left ..... scoop bucket



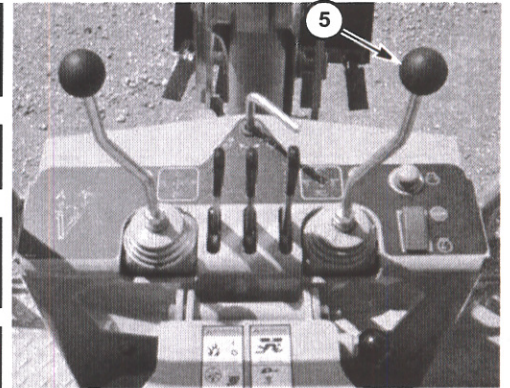

Push right ..... dump bucket



Provided for Free by Trenchwell.com  
Shop Aftermarket Parts

**(6) Remote Creep Lever (Optional)**

 Push down and forward . . . . . move machine forward

 Push down and back . . . . . move machine in reverse

**NOTE:** Remove bolt (7) and creep lever before removing hood.

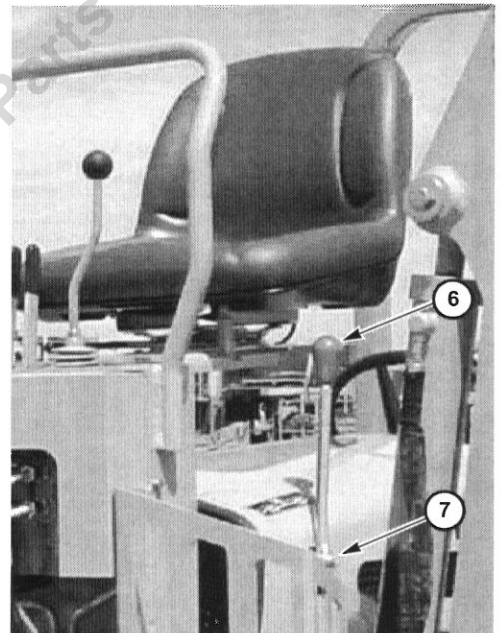

## Backhoe Transport Locks

### (1) Boom Lift Lock Lever

**NOTE:** Boom must be raised before lock can be engaged or disengaged.

Squeeze, pull lever back . . . . . to disengage lock



Squeeze, push lever forward . . . . . to engage lock

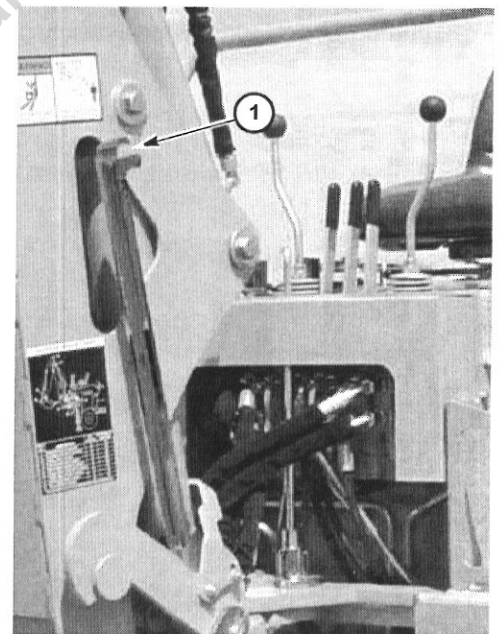

**(2) Boom Swing Lock Pin**

Pull up, turn clockwise, push down . . . . . locked



Pull up, turn counterclockwise, push down . . . . . unlocked

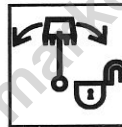

**(3) Stabilizer Latch**

Raise stabilizers. . . . .engage latch

Lower stabilizers. . . . .release latch

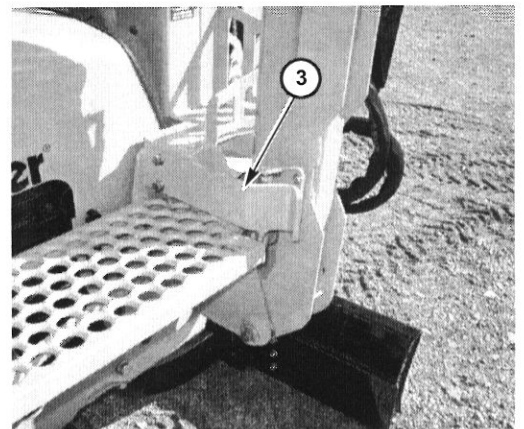
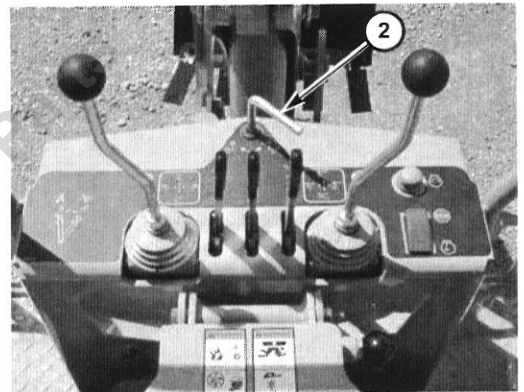

## Engine Start and Stop

### (1) Engine Start Button

Push ..... engine START

**NOTE:** Tractor engine keyswitch must be in RUN position to start engine from backhoe. If necessary, toggle *Engine Shutoff Button* (2) from STOP to RUN.

### (2) Engine Shutoff Button

Push top ..... engine STOP

Push bottom ..... engine RUN

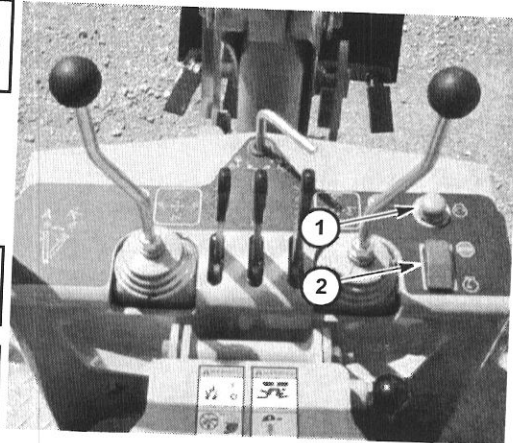

## Seat Assembly

(1) **Seat Rotation Lever**

Pull and rotate seat 90° ..... rotate seat

**NOTE:** Before driving the machine, rotate seat sideways to provide better visibility.

(2) **Seat Lock Pin**

Pull out ..... unlock

Release ..... lock

**NOTE:** Rotate seat mounting plate up for service and storage position. Rotate down to operating and transport position.

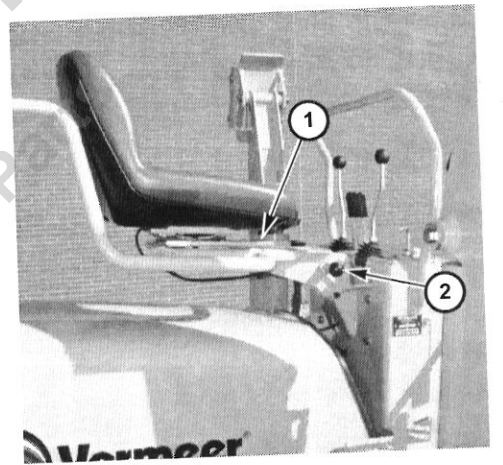

## OPERATING THE BACKHOE

### Backhoe Safety



**WARNING:** Before attempting to operate the machine, refer to "Safety Messages," page 10-1, for important safety information.

Familiarize yourself with the location and function of tractor controls and with each backhoe control before operating. Refer to preceding paragraphs for Backhoe Controls and "Tractor Controls," page 20-1.



**WARNING:** Do not work in trench with unstable sides which could cave in. Cave-in could cause death or serious injury from suffocation. Specific requirements for shoring or sloping trench walls are available from several sources including federal and state O.S.H.A. offices. Contact suitable authorities for these requirements before working in the trench.



**WARNING:** Boom swing can crush or kill.

Boom swing area. Operate from seat. Keep all spectators and other workers away from backhoe swing area during operation.

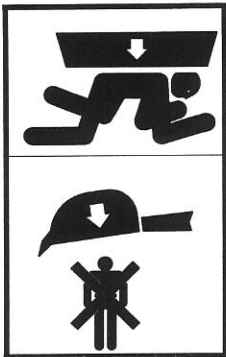

**WARNING:** Falling boom or load can crush.

Use only for excavation, not as an object handler/lifter. Do not swing backhoe over people. The load or backhoe could fall unexpectedly. Never work under an attachment unless it is adequately supported to prevent it from falling unexpectedly.

#### **Rollover Can Crush**

Always lower stabilizers before digging to improve stability when using backhoe.

Do not undermine stabilizers or tractor. Use extra caution in unstable soils.

Do not use remote creep control at backhoe operator station if jobsite conditions are not suitable.

### No Riders in Backhoe Seat

Never allow anyone to ride in backhoe seat while machine is being moved by an operator at tractor controls. The backhoe operator station is not equipped with a Rollover Protective Structure and seat belts.



### Transporting

Before driving or trailering machine, place dipperstick and bucket in a tucked position. Secure backhoe in transport position by engaging boom lift lock and swing lock.

Lower backhoe seat and rotate sideways for improved forward visibility when driving the machine.

Follow instructions in "Transporting the Machine," page 25-1, to load and secure machine on a trailer.

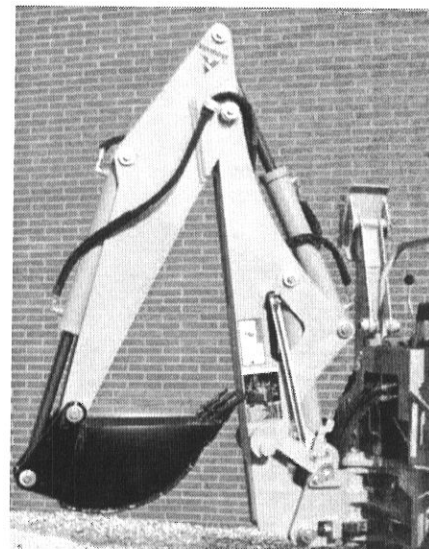

### Backhoe Load Capacity - Model B450

Maximum Bucket Digging Force Calculated per SAE J1179	5652 lbf	25140 N
Maximum Dipper Digging Force Calculated per SAE J1179	2838 lbf	12623 N
Maximum Lifting Capacity Based on 87% Hyd. Capacity @ 2500 PSI (172.3 Bar) Calculated per SAE J31		
Main Boom	890 lb @ -4 ft height	404 kg @ -1.22 m
	920 lb @ -2 ft height	417 kg @ -.61 m
	960 lb @ 0 ft. height	435 kg @ 0.0 m
	1010 lb @ 2 ft height	458 kg @ .61 m
	1070 lb @ 4 ft height	485 kg @ 1.22 m
	1140 lb @ 6 ft height	517 kg @ 1.83 m
	1230 lb @ 8 ft height	558 kg @ 2.44 m
	1300 lb @ 10 ft height	590 kg @ 3.05 m
Dipper Boom	2260 lb @ 6 ft height	1025 kg @ 1.83 m
	2790 lb @ 8 ft height	1266 kg @ 2.44 m
	3960 lb @ 10 ft height	1796 kg @ 3.05 m

## Backhoe Operation

- Step 1: Position machine so digging is near center of swing. Set throttle between idle and 1/3. Use platform and grab handle to move to backhoe operator's seat. Rotate seat to forward position. Operate backhoe controls only while seated.
- Step 2: Lower stabilizers to the ground and level machine.
- Step 3: Lower backfill blade to ground.
- Step 4: Release boom lift and swing locks.

## Dual Operation of Controls

After becoming familiar with operating the backhoe, operators can operate two controls at one time to hasten and simplify the digging operation. When two controls are operated at once, power to each is reduced, so that neither control will have full power.

Smooth, light handling of these controls will result in more efficient backhoe operations. Operating the dipperstick and bucket together will ensure full buckets and prevent lost motion and time.

For example:

- With bucket extended and dipperstick extended, the boom control and dipperstick control can be operated together to bring the bucket toward the operator with downward pressure on it.
- As dipperstick is extended away from you, dipperstick and bucket controls can be operated to move bucket up and away from the operator to save time in clearing the excavation.

## Opening a Trench



**WARNING:** Operate backhoe only while seated at backhoe controls with feet positioned on platforms. Do not move any controls while standing on the ground. Death or serious injury can occur if struck or crushed by the backhoe.

**NOTE:** Bucket must be properly positioned before starting digging operation.

- Step 1: Place dipperstick into a vertical position.
- Step 2: Move dipperstick ahead approximately 2 ft (60 cm).
- Step 3: Position bucket to remove 3–4" (7–10 cm) of spoil from the surface of the ground without dragging heel of bucket.
- Step 4: Lower bucket to the ground, and using downward pressure on bucket, force bucket into the ground.

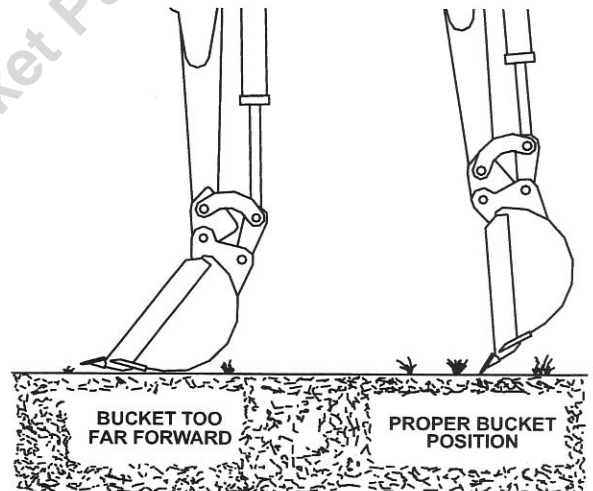

### Digging Procedure

Once bucket is in the ground, simultaneously retract dipperstick and curl bucket until bucket is full.

If bucket stalls, raise boom slightly and continue procedure until sequence is completed. Raise bucket to top of trench and dump spoil.

When loading a truck with high sides, continue to curl bucket while raising boom to minimize spillage.

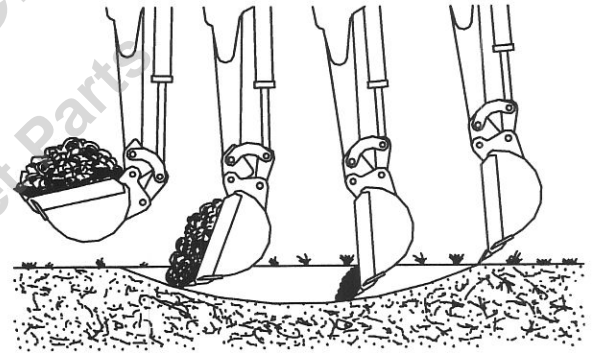

## Remote Creep (Option)



**WARNING:** Rollover can crush. Do not risk rollover. Follow instructions in this section when using remote controls. If jobsite conditions are not suitable for using remote controls, then move to tractor seat, fasten your seat belt, and use tractor controls to move machine.

---

The *Remote Creep Control* allows the backhoe operator to reposition machine while digging. Use creep control only when the following are true:

- travel path is firm and level
- moving five feet (1.5 m) or less away from excavation

## Finishing

When finished excavating with backhoe:

- Step 1: Lock backhoe in transport position.
- Step 2: Raise stabilizers.
- Step 3: Raise backfill blade.
- Step 4: Rotate seat sideways and return to the tractor operator seat.

# Section 45: Trencher

## TRENCHER CONTROLS

### (1) Sliding Offset Shift Lever (Option)

 Push right . . . . . moves trencher up to 24" (61 cm) to right



 Pull left . . . . . moves trencher toward center position



### (2) Hydraulic Trench Cleaner Lever (Option)

**NOTE:** Hydraulic Trench Cleaner Option available only on 8-spool configuration.

 Push right . . . . . lower trench cleaner

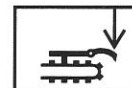

 Pull left . . . . . raise trench cleaner



### (3) Trencher Lift Lever

 Push right . . . . . lower trencher



 Pull left . . . . . raise trencher



8-SPOOL CONFIGURATION

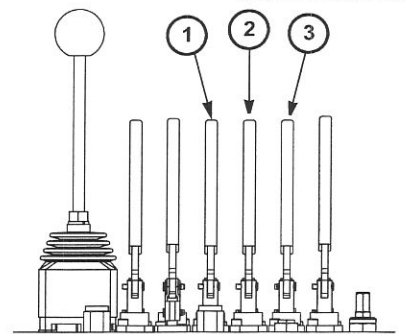

5-SPOOL CONFIGURATION

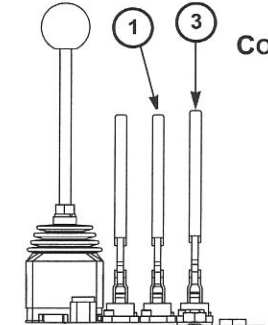

**(4) Attachment Drive Lever**

 Push right (from center) . . . . . variable chain speed FORWARD

Center . . . . . trencher OFF/NEUTRAL

 Pull left (from center) . . . . . variable chain speed REVERSE

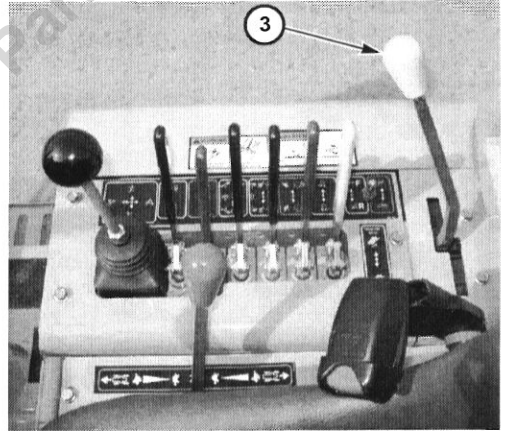

## Trench Cleaner - Manual (Option)

### Manual Fold

With machine shut down, remove hairpin (1), remove lock pin (2). Raise or lower trench cleaner arch (3). Insert lock pin (2), and secure with hairpin (1).

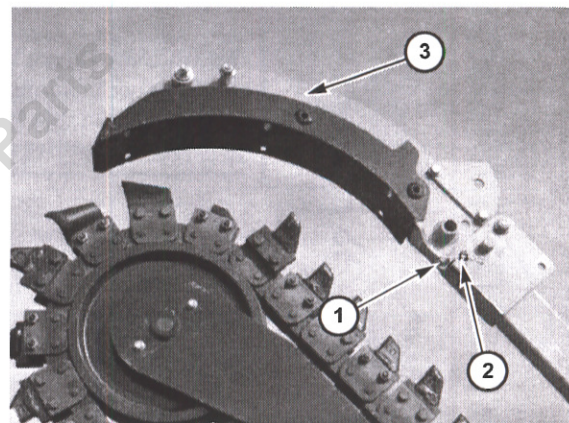

## OPERATING THE TRENCHER

### Trencher Safety



**WARNING:** Before attempting to operate the machine, refer to "Safety Messages," page 10-1, for important safety information.

Familiarize yourself with the location and function of tractor controls and with each trencher control before operating. Refer to preceding paragraphs for *Trencher Controls* and "Tractor Controls," page 20-1.



**WARNING:** Do not work in trench with unstable sides which could cave in. Cave-in could cause death or serious injury from suffocation. Specific requirements for shoring or sloping trench walls are available from several sources including federal and state O.S.H.A. offices. Contact suitable authorities for these requirements before working in the trench.

---

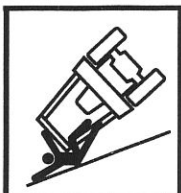

**WARNING:** Rollover possible. Be alert and use extreme caution when operating on hillsides, or near ditches, gullies, holes or obstructions where rollover could occur. Serious injury or death can result if crushed under machine.



Always wear your seat belt. Never allow anyone to be on downhill side of machine.

---

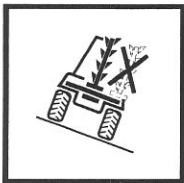

**WARNING:** Rear attachment in offset position reduces machine stability. Rollover may result in serious crushing injury or death. Never drive across slope with rear attachment shifted to downhill side. Center rear attachment before driving machine.

Take precautions to prevent rollover.

When driving across side slopes, place boom in center or uphill position for greater stability.

Avoid slopes where rollover could occur.

Avoid operating next to large holes, ditches, steep banks, or other terrain that may cause the machine to suddenly tip sideways.

Operate at speeds and in a manner consistent with terrain and operating conditions.

## CRYSTALLINE SILICA



**WARNING:** Silica dust can cause illness.

Breathing crystalline silica dust over time can cause silicosis, a disabling, nonreversible, and sometimes fatal disease of the lungs. United States Federal O.S.H.A. has established exposure limits for the jobsite. Avoid exposure to dust containing crystalline silica particles in excess of these limits.

Because crystalline silica is a basic component of sand and granite, many activities at construction sites such as trenching, sawing, and boring of material, produce dust containing crystalline silica. When working in soils containing sand or granite, air monitoring may be necessary to determine whether jobsite conditions expose workers to excessive levels of crystalline silica dust. Depending upon air monitoring results, the following measures may be necessary to avoid exposure to excessive levels of crystalline silica dust:

- Be aware of and follow the guidelines of United States OSHA 29 CFR 1926.55, or other applicable regulatory guidelines.
- Reduce dust concentration using water spray or other methods.
- Use a respirator approved for protection from crystalline silica dust.
- If possible, change into disposable or washable clothes on the jobsite. Shower and change into clean clothing before leaving the jobsite.
- Do not eat, drink, use tobacco products, or apply cosmetics in areas where there is dust containing crystalline silica dust. Wash hands before eating, drinking, or using these products.
- Store food, drink, and personal belongings away from the work area.

## TRENCHING TIPS

For optimum trenching performance:

- Keep trencher chain adjusted properly.
- For light rock or dirt, use cup cutters. In these conditions, using a partial set of cutters can result in increased production. Start with half a full set. Add more cutters if spoil removal is too slow.
- Ensure cutters are in good condition.
- Rock and frost cutting normally require rotary cutters.
- Some digging conditions, such as mixed aggregate rock that fractures easily and crumbles, may go better with a combination cup cutter and rotary cutter setup.
- Do not overload engine while trenching.

## Chain Speed - Set

Trenching and optimum chain speeds will vary depending on digging conditions.

The hydrostatic system has the ability to change chain speeds as digging conditions change.

In average conditions, running chain speed at 50% to 75% speed may result in the best digging.

*To determine the best chain speed for your ground conditions:*

- Step 1: Set *Attachment Drive Lever (1)* at 50% to 75% speed.
- Step 2: Adjust chain speed until engine speed increases, then increase ground speed. Never run chain below 50% speed.
- Step 3: Continue adjusting chain and ground drive speeds until optimum trenching production is achieved for digging conditions.

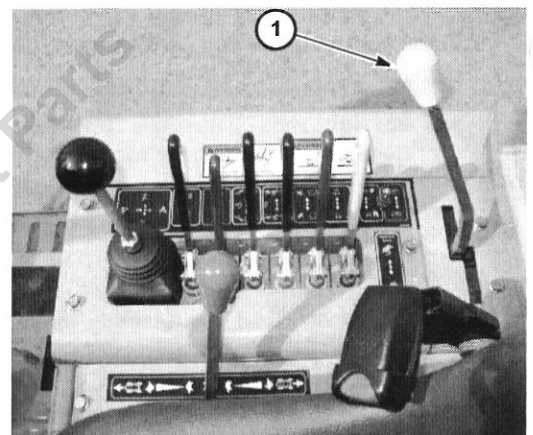

**Digging Conditions**

- Rock digging ..... slow chain speed
- Frost digging ..... fast chain speed
- Muddy conditions..... fast chain speed

It is not unusual to run the chain slower for maximum production. Some digging conditions such as rock digging require a great deal of force to carry the cutter through the material.

Mud, especially gumbo, plugs the chain quickly, so faster chain speeds are required to fling mud from the cutters.

Vary chain speed to find the best setting that maximizes cutting footage and carbide life.

## Trenching

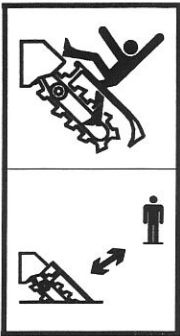

**DANGER:** Moving digging chain can kill or cut off arm or leg. Trench cave-in may cause you to fall onto moving chain.

Stay away from moving digging chain.

When operating trencher, never allow anyone to stand at edge of trench above or near digging chain. The trench might cave in, causing you to fall onto digging chain.

## Trench Cleaner Assembly (Option)/Restraint Bar

The trench cleaner assembly or the restraint bar is intended to help protect against accidental personal contact with the digging chain. The trench cleaner assembly or restraint bar must be in place while digging.

## Starting the Trench

- Step 1: If equipped with sliding offset bracket, use *Trencher Shift Lever* to slide attachment to desired position.
- Step 2: Line up machine at beginning of trench.
- Step 3: Push *Trencher Lift Lever* right to lower digging chain boom until chain is just off the ground.



**WARNING:** Contact with a moving digging chain will result in serious injury or death.  
Never manually adjust trench cleaner assembly with the digging chain or engine running.

- Step 4: Raise trench cleaner arch:

**Manual Trench Cleaner (Option)** - Shut off engine and engage park brake. Remove hairpin (1), remove lock pin (2). Raise trench cleaner arch (3), insert lock pin and hairpin in new location (4) to lock trench cleaner in upright position.

**Hydraulic Trench Cleaner (Option)** - Pull *Trench Cleaner Fold Lever* left to raise hydraulic trench cleaner.

**NOTE:** It is not necessary to shut off engine and engage park brake before raising hydraulic trench cleaner.

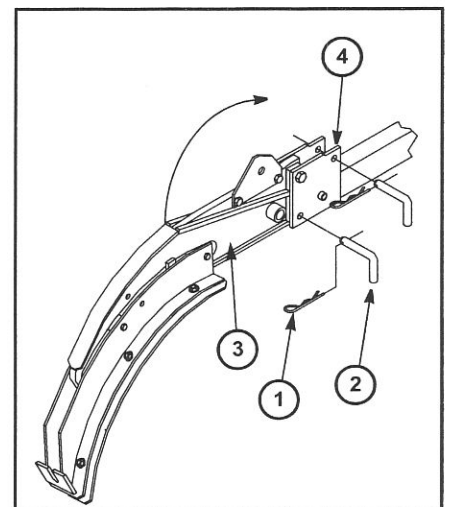

**IMPORTANT:** A trench can be started without raising the trench cleaner, but the trench cleaner bridge tube can bend if boom is lowered into the ground without also moving the machine forward.

- Step 5: For machines equipped with manual trench cleaner, restart engine and disengage park brake.
- Step 6: Push *Throttle Lever* (4) up to increase engine speed to full RPM.
- Step 7: Push *Attachment Drive Lever* (5) to start digging chain.
- Step 8: Push *Trencher Lift Lever* right to gradually lower digging chain boom to desired digging depth.

**NOTE:** Do not overload engine. If engine lugs down or digging chain slows down, raise boom until speed increases, then continue lowering boom.

- Step 9: Move machine forward approximately 3 ft (1 m) while making plunge cut.
- Step 10: Place ground drive controls in NEUTRAL, shut off digging chain, and raise boom to horizontal position.

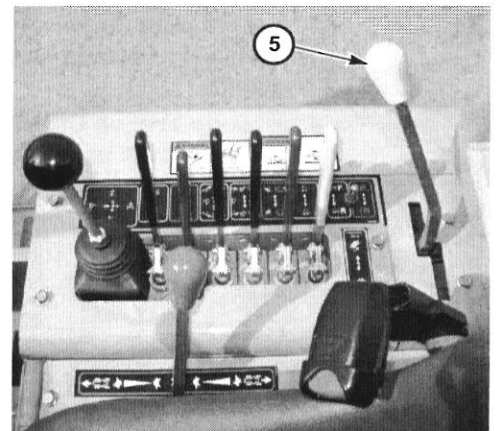

Step 11: Lower trench cleaner arch:

**Manual Trench Cleaner (Option)** - Shut off engine and engage park brake. Remove lock pin (1) and lower trench cleaner arch. Insert lock pin and secure with hairpin (6).

**Hydraulic Trench Cleaner (Option)** - Push *Trench Cleaner Fold Lever* right to lower hydraulic trench cleaner. Ensure linkage is in full locked position.

**NOTE:** It is not necessary to shut off engine and engage park brake before lowering hydraulic trench cleaner.

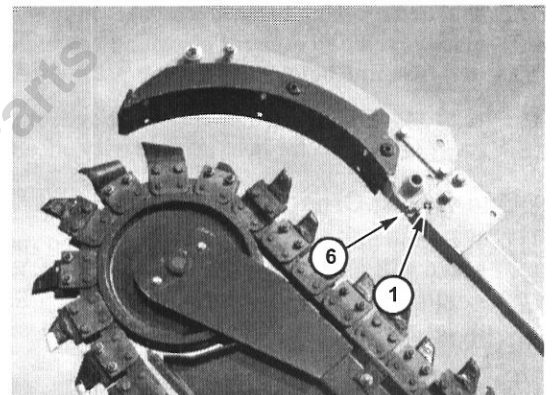

**WARNING:** Contact with a moving digging chain will result in serious injury or death. Never adjust trench cleaner assembly with the digging chain or engine running.

Step 12: For machines equipped with manual trench cleaner, restart engine and disengage park brake.

Step 13: Push *Trench Lift Lever* right to lower boom into trench and follow guidelines in “Chain Speed - Set,” page 45-8.

**NOTE:** Lowering boom too quickly may result in excessive boom and machine bounce. A small amount of ground travel during plunge cut may help reduce boom and machine bounce.

Step 14: Use *Creep Lever (7)* to move machine forward. Adjust ground drive speed for best productivity once required trench depth is reached.

### Overriding Creep Lever

If engine pulls down too far, pushing on rear of *Ground Drive Pedal* to slow creep speed will allow engine to pick up speed. Releasing pedal will return machine to original speed. If digging becomes easier for a short distance, pushing on front of pedal will increase machine creep speed without changing creep lever setting.

### Completing the Trench

- Step 1: Move *Ground Drive* and *Creep Controls* to NEUTRAL to stop machine travel.
- Step 2: Raise boom slowly. When chain is just above ground level, move *Attachment Drive Lever* to NEUTRAL.
- Step 3: Lower engine RPM to idle.
- Step 4: If equipped with sliding offset bracket, slide attachment to center position before driving machine.

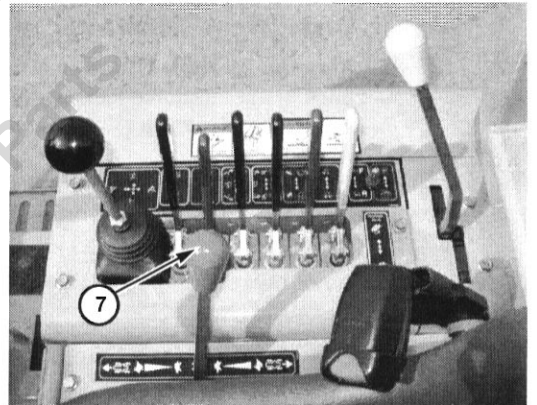

# Section 50: Plow

## PLOW CONTROLS

### (1) Plow Lift Lever

Push right ..... lower plow frame



Push right to detent ..... plow float



Pull left ..... raise plow frame

### (2) Plow Swing Lever



Push right ..... swing plow right

Pull left ..... swing plow left



Pull left to detent ..... plow swing float

### (3) Plow Steer Lever



Push right ..... plow steers right



Pull left ..... plow steers left

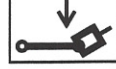
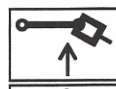

### 8-SPOOL CONFIGURATION

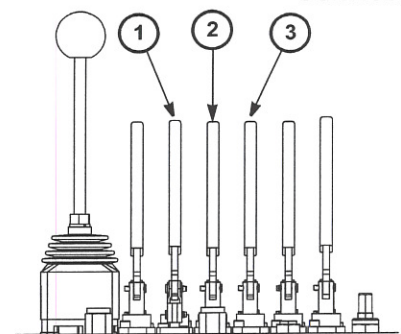

**NOTE:** Plow is available only on machines with an 8-spool configuration.

**(4) Attachment Drive Lever**

**NOTE:** Shaker speed is also affected by engine RPM.

 Pull left (from center) . . . . . engage and increase speed  
Variable shaker speed increases as lever is moved from center.

Center . . . . . shaker OFF

 Push right . . . . . DO NOT USE

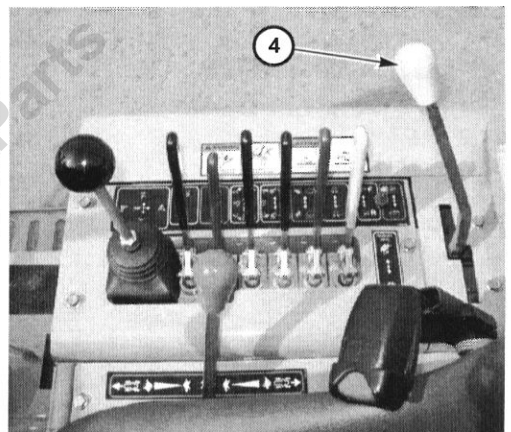

### Sod Cutter (Option)

The optional sod cutter (1) should cut 2–3" (5–8 cm) deep into the soil.

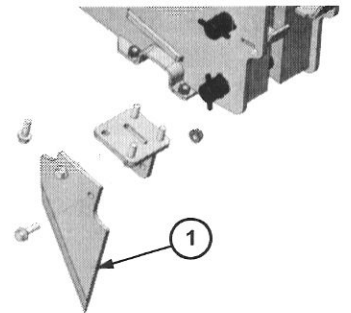

### Plow Transport Lock

Plow transport lock (1) engages automatically when plow is fully raised. Lower plow slightly to fully engage transport lock. Pull lock lever (2) back to disengage lock for plow operation. Plow must be raised slightly to disengage lock.

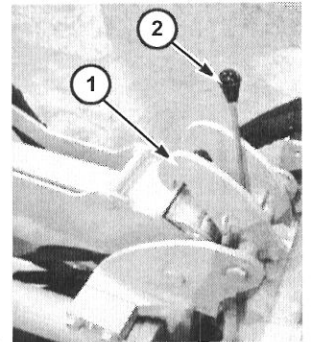

## PLOW BLADE - INSTALL

### Without Hanger Holes

- Step 1: Lower plow frame.
- Step 2: Position blade in rear slot of plow shaker box.
- Step 3: Align top hole in blade with corresponding hole in shaker box.
- Step 4: Install top pin (1) and keeper pin (2).
- Step 5: Rock bottom of blade forward to align blade mounting holes and install bottom blade mount pin (3) and keeper pin (4).

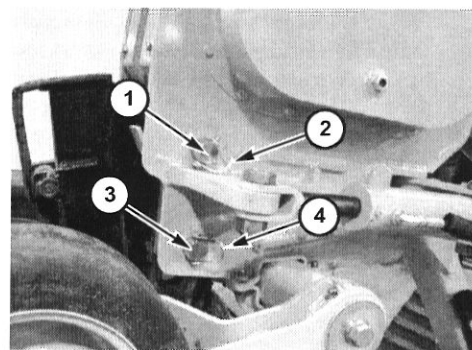
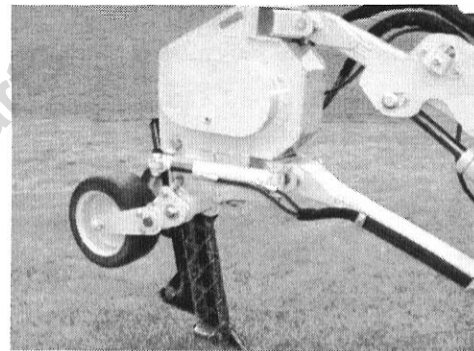

### With Hanger Holes

Step 1: Lower plow frame to allow pin (1) to engage mounting bracket (2) when pin is in one of holes (3).

Step 2: Install 3/4" round pin (1) into blade hanger hole (3) in blade (4).

Step 3: Position blade with hanger pin into mounting bracket (2).

Step 4: Raise plow frame so that blade hangs freely.

Step 5: Rock bottom of blade forward to align blade mounting holes and install bottom blade mount pin (5) and keeper pin (6).

Rock top of blade forward to align blade mounting holes and install top blade mount pin (7) and keeper pin (8).

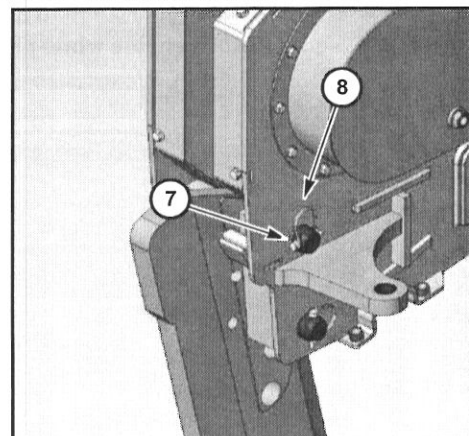
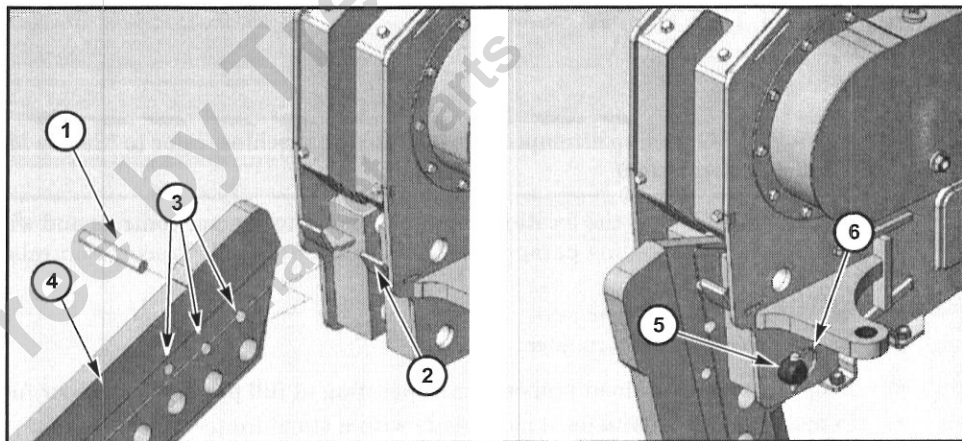

## OPERATING THE PLOW

### Plow Safety



**WARNING:** Before attempting to operate the machine, refer to “Safety Messages,” page 10-1 section for important safety information.

Familiarize yourself with the location and function of the Tractor controls and with each Plow control before operating. Refer to preceding paragraphs for *Plow Controls* and “Tractor Controls,” page 20-1.

### Plowing Tips

For optimum plowing performance:

- Keep tractor maintained properly and operating at full power. Use proper fuel, oil, and hydraulic oil.
- In most ground conditions, a plow blade with a standard toe is required.
- Keep plow blade sharp and in good condition.
- Do not overload engine while plowing.

## Plowing - Start with Bell Hole or Trench



**WARNING:** Do not work in trench with unstable sides which could cave in. Cave-in could cause death or serious injury from suffocation. Specific requirements for shoring or sloping trench walls are available from several sources including federal and state O.S.H.A. offices. Contact suitable authorities for these requirements before working in the trench.

**NOTE:** Use a bell hole or trench to enable plow blade (B) to be lowered and easily started at desired depth.

- Step 1: Lower blade (B) to the ground. Follow *Shutdown Procedure*, page 23-1.
- Step 2: Remove feed tube gate (A).
- Step 3: Install cable (C) into feed tube (D). Reinstall feed tube gate (A) and secure. Anchor free end of cable to prevent it from being pulled into the plow cut.

**NOTE:** Use a feed tube (D) with an inside diameter at least 1/4" (6 mm) larger than cable (C).

- Step 4: Follow *Starting Procedure*, page 22-1. Move machine into starting position.
- Step 5: Lower plow blade (B) into starting hole.
- Step 6: Using *Creep Lever* or *Ground Drive Pedal*, move machine and lower plow until plow blade contacts dirt.
- Step 7: Move *Plow Lift Lever* and *Plow Swing Lever* to FLOAT position.
- Step 8: Continue to pull into dirt without engaging shaker until wheels start to slip.
- Step 9: Move *Attachment Drive Lever* to 2/3 speed to start shaker. Continue moving the machine forward until tamping wheels contact the ground.

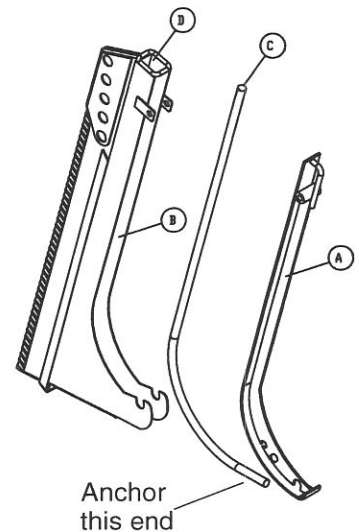

## Plowing - Start without Bell Hole or Trench

**NOTE:** To start plow without a bell hole requires some distance of travel before plow blade reaches its full depth.

- Step 1: Position machine and plow blade **(B)** at starting point. Lower blade to the ground.
- Step 2: Follow *Shutdown Procedure*, page 23-1.
- Step 3: Remove feed tube gate **(A)**.
- Step 4: Install cable **(C)** into feed tube **(D)**. Reinstall feed tube gate **(A)** and secure. Anchor free end of cable to prevent it from being pulled into the plow cut.

**NOTE:** Use a feed tube **(D)** with an inside diameter at least 1/4" (6 mm) larger than cable **(C)**.

- Step 5: Follow *Starting Procedure*, page 22-1. Place *Plow Lift Lever* in FLOAT position and pull plow blade into the ground.
- Step 6: Move ahead until plow blade is approximately halfway into the ground.
- Step 7: Move *Plow Swing Lever* to FLOAT position.
- Step 8: Move *Attachment Drive Lever* to 2/3 speed to start shaker and continue forward travel until plow blade is at full depth. Continue moving the machine forward until tamping wheels contact the ground.

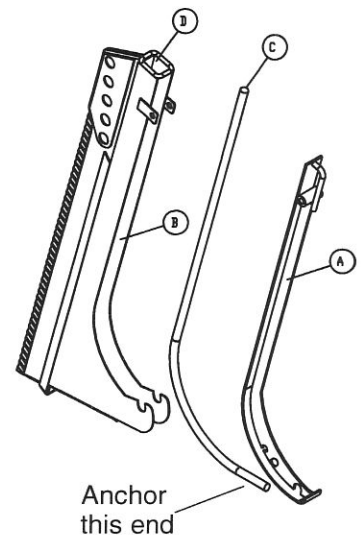

## Plowing - Continue

**NOTE:** Plow lift must be in the FLOAT position during plowing operation to prevent excessive vibration and shaker force from being transmitted to other areas of machine. Operating the plow without the lever in FLOAT or using the lever to carry or force down the plow will result in damage and/or failure of plow and machine components. The swing control may be taken out of float position if it is necessary to maintain maximum offset.

Step 1: Increase engine speed to full RPM.

**NOTE:** A fast forward speed can cause plow to lift up out of the ground in hard plowing conditions. Too fast a forward speed will cause tires to break traction.

Step 2: Adjust ground speed and shaker speed for optimum plowing speed. Do not overload engine. Plowing speed will depend on ground conditions and the size and style of plow blade.

**IMPORTANT:** Keep load against plow blade while operating the plow shaker. The force and vibration created by the shaker must be absorbed into the ground. If shaker is operated without a load against blade or with plow blade raised out of the ground, damage to the plow and/or machine components will result.

## Shaker Speed - Set

Optimum ground and shaker speeds are dependent upon soil conditions. Maximum shaker speed may not be the most efficient; it uses more power and produces less up-and-down movement than lower speeds, but does provide the greatest amount of shaker force if needed. The hydraulic drive allows shaker speed to be adjusted as conditions require.

*To determine the best RPM for ground conditions:*

- Step 1: Move Attachment Drive Lever (1) 3/4 of the way to full speed.
- Step 2: Set ground speed.
- Step 3: Adjust shaker speed up or down until engine RPM increases; then increase ground speed.
- Step 4: Repeat until optimum ground and shaker speeds are reached.

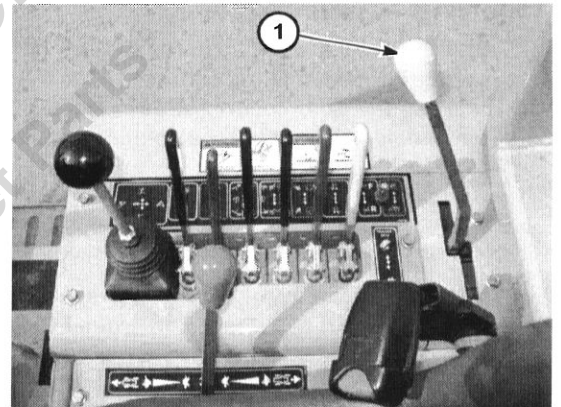

## Steering

- Step 1: With forward motion and *Plow Swing Lever (1)* in FLOAT position, use *Plow Steer Lever (2)* to reposition plow. Push lever to steer plow right; pull to steer plow left.
- Step 2: After plow reaches maximum swing, realign plow blade with direction of travel to avoid slowing forward plow movement. Returning *Plow Swing Lever* to CENTER or applying some outward pressure with swing cylinder may help maintain maximum plow steer.
- Step 3: Further adjustment (i.e., steering back to center) requires moving *Plow Swing Lever* to FLOAT position.

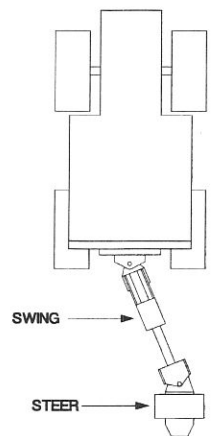
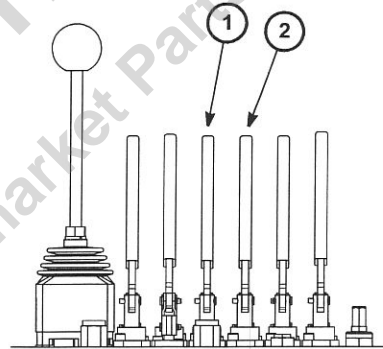

## Offset Plowing Position

It is possible to start plowing from an offset position. After following “Steering” Steps 1–3:

Step 1: Swing plow to required position.

Step 2: Lower plow until ground contact is made.

Step 3: Position plow blade steer so that blade is aligned with the direction of travel.

**NOTE:** Failure to realign blade after maximum swing is reached will significantly slow forward plow movement.

Step 4: Proceed as previously described to lower blade into the ground. Refer to “Plowing - Start with Bell Hole or Trench,” *page 50-7*.

**IMPORTANT:** Removing plow blade from the ground in an offset position without an exit pit can cause damage due to side load pressure against the blade. Pressure is dependent on ground conditions, amount of offset, and blade length. The worst condition is very hard ground with full offset and a maximum-length blade. To eliminate pressure, turn plow blade until it points toward swing pivot center, or reduce amount of offset before removing plow blade from the ground.

### Plowing - Stop with Bell Hole

- Step 1: Disengage shaker drive by moving *Attachment Drive Lever* to NEUTRAL as plow blade enters the bell hole.
- Step 2: Return *Ground Drive Controls* to NEUTRAL to stop machine travel.
- Step 3: Lower engine RPM.
- Step 4: Remove feed tube gate and cable from feed tube.
- Step 5: Raise plow slowly to engage the *Plow Transport Lock*.
- Step 6: Follow *Shutdown Procedure*, page 23-1.

### Plowing - Stop without Bell Hole

**NOTE:** Stopping plowing without a bell hole requires some distance of travel. If the feed tube gate can be removed with plow blade at full depth, the required forward travel while removing plow blade can be reduced without damaging product.

- Step 1: Reduce shaker drive speed by moving *Attachment Drive Lever* toward NEUTRAL while raising the plow blade, creeping forward, and stopping the shaker drive as plow blade exits the ground.
- Step 2: Return *Ground Drive Controls* to NEUTRAL to stop machine travel.
- Step 3: Lower engine RPM.
- Step 4: Remove feed tube gate and cable from feed tube.
- Step 5: Raise plow slowly to engage the plow transport lock.
- Step 6: Follow *Shutdown Procedure*, page 23-1.

Provided for Free by Trenchwell.com  
Shop Aftermarket Parts

This page intentionally left blank.

11/11/2019 10:00:00 AM

## Section 55: Porta Bore

### PORTA BORE CONTROLS

#### (1) Auxiliary Tool Switch

 Lift and push right. . . . . runs boring motor FORWARD  
Center. . . . . OFF

 Lift and pull left. . . . . run boring motor in REVERSE

**NOTE:** Always use FORWARD when boring. Reversing motor when using threaded-pipe type drill rod will uncouple rod in bored hole.

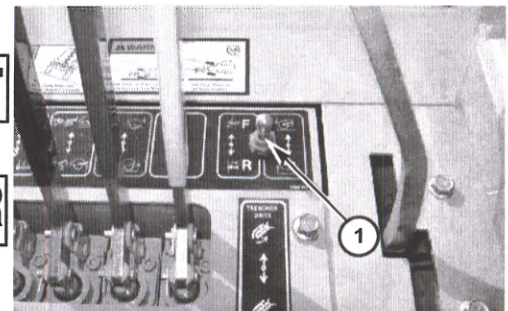
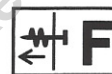

### PORTA BORE OPERATION

#### Porta Bore Safety



**WARNING:** Before attempting to operate machine, refer again to “Safety Messages,” page 10-1, for important safety information.

Familiarize yourself with location and function of machine controls and Porta Bore controls before operating. Refer to preceding paragraphs for *Porta Bore Controls* and “Tractor Controls,” page 20-1.

## Drill Rod Safety



**WARNING:** Check overhead for electrical power lines or other obstructions and be certain there is adequate clearance when handling drill rods. Contact with overhead electrical lines may cause death or serious injury.



**WARNING:** Rotating rod can kill. Clothes can snag.

Stay away. Do not wear loose clothing that could catch on rotating equipment. Boring rotation lever must self-center to NEUTRAL and stop rod motion.

- Drill rod connectors are designed not to snag clothing. Never substitute bolts or pins as a means to connect drill rods.
- Never allow anyone near boring attachment or any of its rotating parts while it is operating.

### Thrown Wrench

Serious injury is possible if struck by pipe wrench on drill rod. The wrench could strike a worker or bystander if drill rod rotation is started.

#### **Do Not Allow Drill Rod to Whip**

Whipping action is extremely powerful and can injure anyone within reach.

- Always start boring attachment at a low engine RPM.
- Never have more than 20 ft (6 m) of drill rod exposed between bore entrance and machine.
- Control forward travel speed to avoid bending rod, causing drill string to whip.

#### **Work Area - Check/Clear**

Clear work area of all objects that might interfere with proper operation of boring unit.

If tool turns but does not move forward, turn off machine. Check to ensure tool is not in contact with a gas line, water line, electrical line, or some other underground obstruction that can be damaged or cause personal injury.

### Boring Attachment and Shield - Check

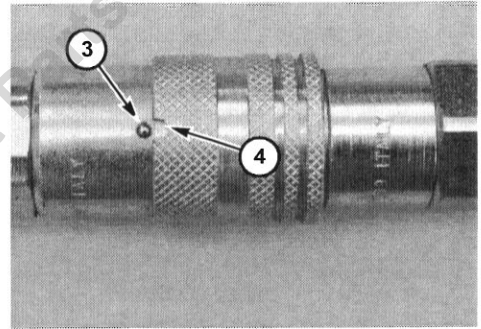
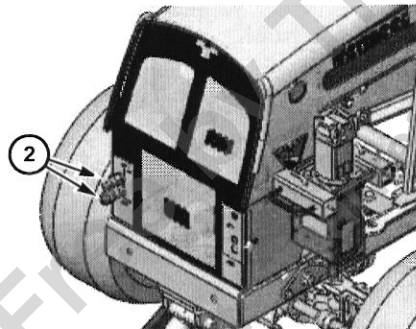
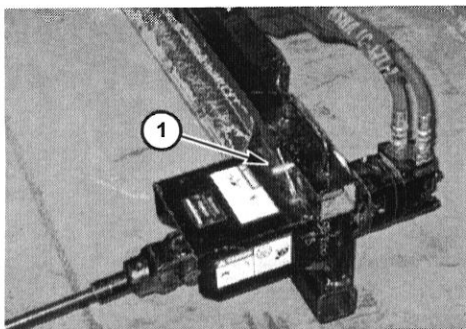

- Ensure boring attachment mount is properly bolted to the backfill blade with two 5/8" grade 8 fasteners. Torque to 180 ft-lb (245 Nm).
- Ensure boring attachment is properly and securely attached to boring attachment mount with pin (1).
- Keep boring motor output shaft shield in place and properly secured.
- Attach hydraulic connectors to couplers (2) on machine.
- Align pin (3) with notch (4) on female coupler before disconnecting couplers.

**NOTE:** Follow *Shutdown Procedure*, page 23-1. Turn key to ON position, but do not start engine. Cycle *Auxiliary Tool Switch* to relieve residual line pressure before connecting or disconnecting couplers.

### Use Two People for Porta Bore Operation

Boring requires a trained operator and a trained helper. Operator must be present at the machine, operating the controls. The helper aligns the bore, changes drilling rods, attaches cutters, and watches drilling operation.

### Shaft Angle - Limit

Limit drill shaft offset angle to 15° at Porta Bore universal joint.

Excessive angle could break extension shaft, universal joint, or hydraulic motor.

### Trench - Set Up

A trench or pit may be needed on both ends of the area to be bored.

Entrance trench (**A**) should be as deep as the proposed bore and about three times as long, depending on grade of bore. End trench as close to the obstruction as possible.

Dig a second trench (**B**), deeper than the desired drilling depth, on the other side of the obstruction across the bore path. The longer the bore, the longer and deeper this trench should be to intercept a bore that may deviate off course.

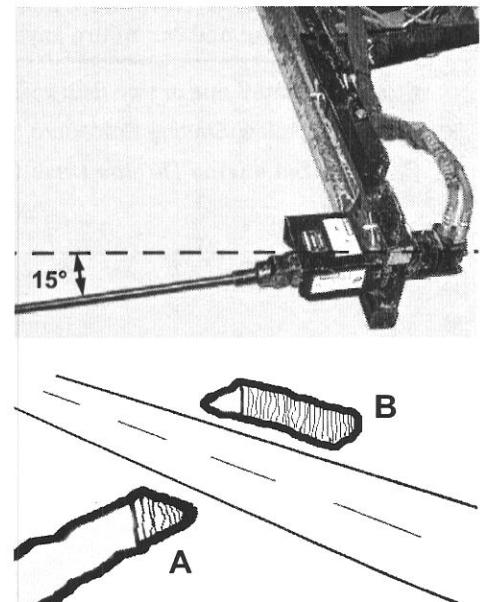

## Machine - Set Up for Boring

Step 1: Position machine for boring. Follow *Shutdown Procedure*, page 23-1.



**WARNING:** Never have more than two drill rods exposed. The whipping action of the flexible rod is extremely powerful and can injure anyone within reach.

Step 2: Install one or two drill rods and desired cutter.

Step 3: Follow *Starting Procedure*, page 22-1.

Step 4: Set engine *Throttle Lever (1)* at a low RPM.

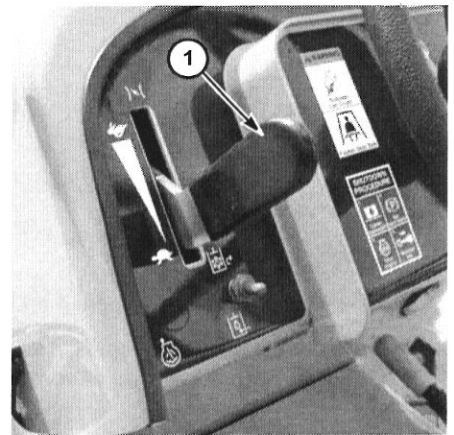

## Cutting Head - Guide



**WARNING:** Never use hands, feet, shovels, rakes, or other tools to manually assist the boring attachment. Serious injury or death is possible if stuck by guide tool.

The helper may guide and align the cutting head to the point of cutter head entry, ensuring that the following safety requirements are met:

- Helper must only use rod guide tool (1) supplied with boring attachment.
- Rod guide tool must be positioned behind the cutting head.
- Helper must be outside of entrance pit, standing to the side of the turning drill rod (2) as shown. This position will prevent helper from being struck by rod guide if it catches on the drill rod or cutting tool.
- Rod guide tool must be removed when cutting head has entered the ground.
- When guide tools are necessary, use a tool specifically designed to guide boring rods.

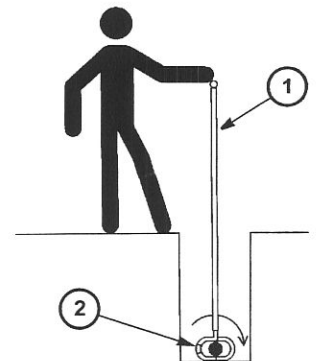



**WARNING:** Electrocution possible. Serious injury or death may result if boring tool strikes an underground electrical power line. Take the following precautions to prevent injury or death.

- Qualified persons must locate underground utilities.
- Never stand on ground and touch metal parts on boring attachment or machine when boring or backreaming.
- Never step off tractor if an electric strike occurs. If strike occurs, stay on machine. Have someone who is clear of the area contact the utility company to shut off electrical power. Do not allow anyone to approach the machine.

### Start Boring

Always use forward rotation when boring. Reversing the motor direction when using threaded-pipe type drill rod may uncouple the rod in the bored hole. Reverse motor less than one revolution if drill bit has hit an obstruction and is stuck. Refer to "Motor Direction - Reverse," page 55-9.

Step 1: Run engine at low RPM.

Step 2: Lift and push *Auxiliary Tool Switch* right to run boring tool FORWARD.

Step 3: Drive tractor forward slowly. If drill string begins to bend, slow down machine forward travel.

### Operation - Check

Shut down machine at first sign of malfunction or hazardous condition.

If tool turns but does not move forward, turn off machine. Check to ensure tool is not in contact with a gas line, water line, electrical line, or some other underground obstruction that can be damaged or cause personal injury.

### Drill Rod Grade - Check

Step 1: After cutting head has entered the ground, shut off machine and remove rod guide tool.

Step 2: Check grade of rod with a level.

Step 3: Make necessary adjustments, restart machine and continue the bore.

### Motor Direction - Reverse

If drill bit hits an obstruction and is stuck, reverse motor direction while backing up tractor to back out the rod.

**IMPORTANT:** Do not reverse rotate more than one revolution if using threaded drill rod.

Step 1: Lift and pull *Auxiliary Tool Switch* left to reverse motor direction while backing up tractor.

Step 2: Resume boring at a new location to avoid the obstruction.

### Rod- Install Additional

When the last 12–18" (30–46 cm) of drill string is still exposed, shut off machine. Uncouple drill string and install an additional rod.

### Universal Joint - Remove



**WARNING:** Personal injury or damage to boring attachment may result if hydraulic motor is started with only universal joint attached.

When finished boring, remove universal joint from Porta Bore motor.

### Guide Stakes

Vermeer auger-type guide stakes (1) may be used to guide the drill rods. Place them 10 ft (3 m) apart in trench. Position drill rods within loops of each guide stake.

If it is necessary to avoid obstacles, machine can be moved slightly to side for offset boring. Use guide stakes to direct drill rod.

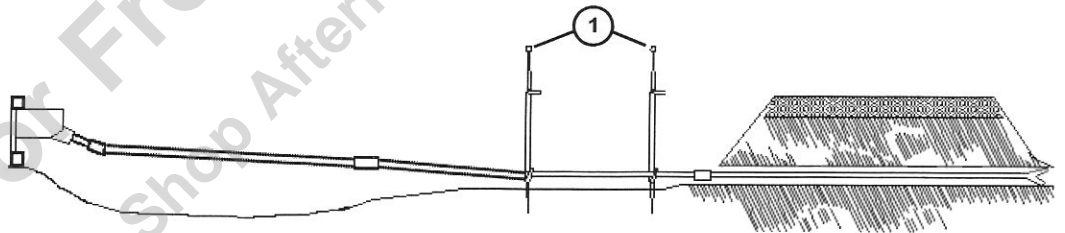

## Backreaming

### Cutting Tool - Change

When the cutting tool has exited the bore and is visible in the exit pit or trench:

- Step 1: Follow *Shutdown Procedure*, page 23-1.
- Step 2: Remove cutting tool and install backreaming tool or pullback tool.
- Step 3: Connect and turn on water supply to water jacket if equipped.

### Water Jacket (Option)

Use optional water jacket attachment (1) when backreaming, or if ground is dry and hard. Connect a standard garden hose to inlet fitting (2).

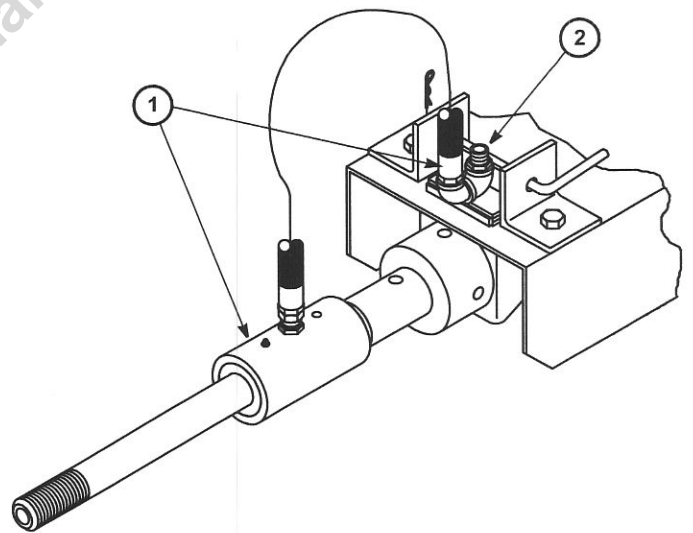

### Reaming - Start

Station helper outside entrance pit. Clear entrance trench area.

- Step 1: Follow *Starting Procedure*, page 22-1, and run engine at low RPM.
- Step 2: Drive tractor in reverse until reaming tool is at hole opening.
- Step 3: Lift and push *Auxiliary Tool Switch* right to run boring tool FORWARD.
- Step 4: Drive tractor backward slowly until a rod coupling emerges from bore entrance.

### Drill Rod - Remove

- Step 1: Follow *Shutdown Procedure*, page 23-1.
- Step 2: Uncouple and remove rod connected to Porta Bore motor.
- Step 3: Follow *Starting Procedure*, page 22-1.
- Step 4: Move tractor toward entrance trench. Follow *Shutdown Procedure*, and recouple to drill string.
- Step 5: Clear the area and station helper outside the pit.
- Step 6: Follow *Starting Procedure*. Continue removing one rod at a time until backreamer is withdrawn from the bore.

## PORTA BORE TRANSPORT/STOW

*To transport or stow the Porta Bore attachment:*

- Step 1: Disconnect hydraulic hoses from couplers (1).
- Step 2: Attach Porta Bore basic unit to transport bracket (2) and secure with pin (3) and hairpin.
- Step 3: Wind hydraulic hoses securely around Porta Bore basic unit.

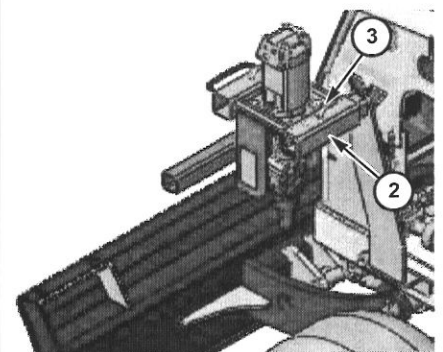
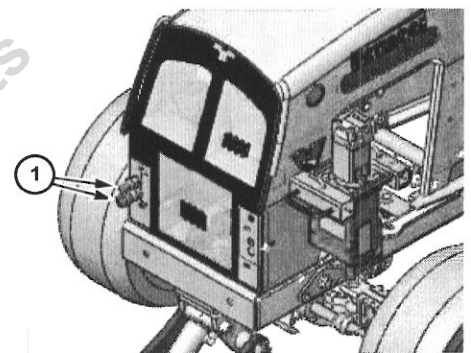

Provided for Free by Trenchwell.com  
Shop Aftermarket Parts

This page intentionally left blank.

## Section 60: Reel Carrier

### REEL CARRIER CONTROLS

#### (1) Auxiliary Tool Switch

- |   |                               |                              |  |
|---|-------------------------------|------------------------------|--|
|  | Lift and push right . . . . . | lower reel carrier           |  |
|   | Center . . . . .              | reel carrier lift stationary |  |
|  | Lift and pull left . . . . .  | raise reel carrier           |  |

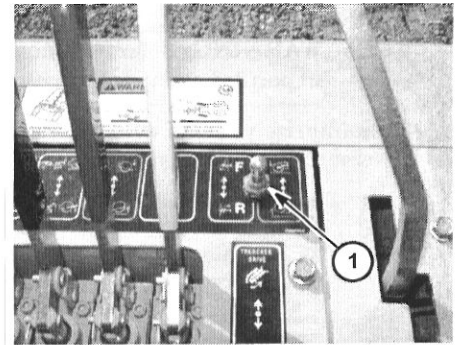

## OPERATING THE REEL CARRIER

### Reel Carrier Safety



**WARNING:** Before attempting to operate the machine, refer to “Safety Messages,” *page 10-1*, for important safety information.

Familiarize yourself with the location and function of the tractor controls and reel carrier before operating. Refer to “Reel Carrier Controls” in this section.



**WARNING:** For improved stability and to reduce risk of rollover, lower reel carrier as close to the ground as possible when driving the machine or loading onto a trailer.



**WARNING:** Never work under an attachment unless it is adequately supported to prevent it from falling. The attachment may fall or shift, crushing anyone beneath it.

### Machine Counterweights

Use of reel carrier requires counterweighting. Refer to the “Counterweight Requirements,” *page 5-1*.

## Carry Reels Only



**WARNING:** Do not use reel carrier to lift or transport anything other than reels. Do not attempt to lift or transport reels heavier than the rated capacity of the reel carrier. Reel carrier has a rated capacity of 500 lb (227 kg).

## Reel Carrier - Hydraulic Attachment

- Attach hydraulic couplers on reel carrier attachment to couplers (1) on machine.
- Align pin (2) with notch (3) on female coupler before disengaging couplers.

**NOTE:** Follow *Shutdown Procedure*, page 23-1. Turn key to ON position, but do not start engine. Cycle *Auxiliary Tool Switch* to relieve residual line pressure before connecting or disconnecting couplers.

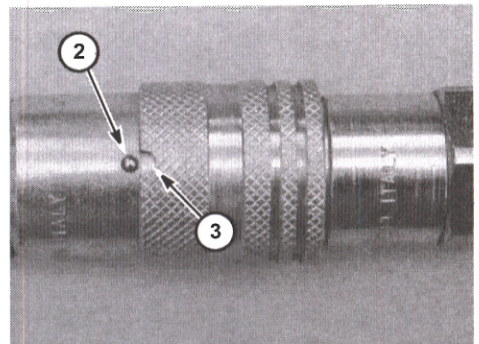
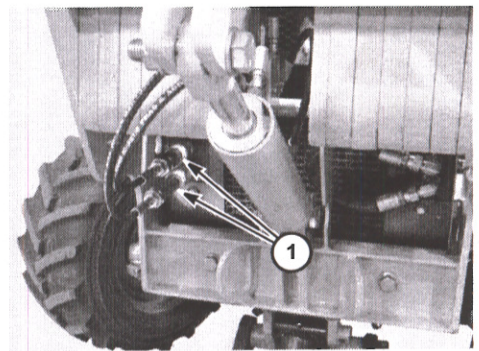

### Load Reel

- Step 1: Remove lock pin (1) on each end of reel shaft.
- Step 2: Remove shaft (2). Slip shaft through center of reel and center reel on shaft.
- Step 3: Install shaft and lock pin.

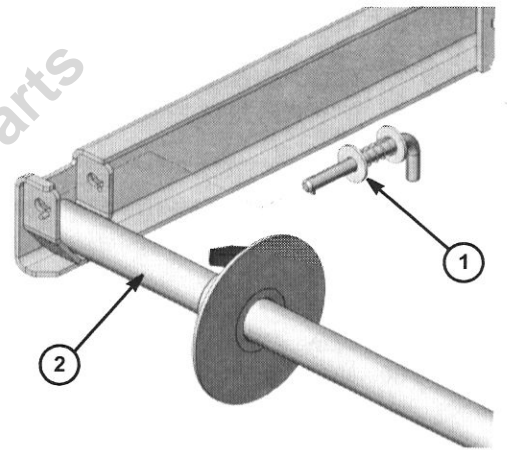

## Section 65: Maintenance Schedule

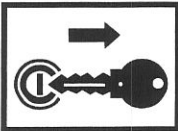

**WARNING:** Before servicing, cleaning, repairing, inspecting, lubricating, fueling, or transporting the machine, refer to *Shutdown Procedure*, page 23-1, for proper instructions.

Visually inspect machine daily before starting the machine.

Make no modifications to your equipment unless specifically recommended or requested by Vermeer Corporation.

### SAFETY SIGNS

Safety signs located on your machine contain important and useful information that will help you operate your equipment safely. Refer to the *Parts Manual* and "Tractor Controls," page 20-1 for locations.

To assure that all safety signs remain in place and in good condition, follow the instructions given below:

- Keep safety signs clean. Use soap and water - not mineral spirits, abrasive cleaners, or other similar cleaners that will damage the sign.
- Replace any damaged or missing safety signs. When attaching signs, the temperature of the mounting surface must be at least 40°F (5°C). The mounting surface must also be clean and dry.
- When replacing a machine component with a safety sign attached, replace the safety sign also.
- Replacement safety signs can be purchased from your Vermeer equipment dealer.

## **MAINTENANCE MANUAL**

Maintenance intervals are included for reference only. Before performing any maintenance, refer to the *Maintenance Manual* for safety guidelines and correct procedures.

Refer to the Engine Operation Manual for additional information and service requirements. Shorten maintenance intervals when operating under dusty, dirty conditions.

## **MACHINE - GREASE**

As a general rule, grease machine after it is shut down for the day. This protects metal under seals from corrosion caused by condensation as temperature drops.

Ensure all fittings and nozzle of grease applicator are clean before applying grease. If any grease fittings are missing, replace them immediately.

## **HOURLY METER - CHECK FOR MAINTENANCE INTERVAL**

The hourmeter is used to determine maintenance intervals for the machine. The hourmeter indicates the total number of hours the engine has been in operation.

Maintenance intervals are based on normal operating conditions. When operating under severe conditions, the maintenance intervals should be shortened.

## MAINTENANCE INTERVALS

Initial = Initial maintenance on new machine. Regular maintenance interval may be different.

● = Regular maintenance interval.

For Vermeer maintenance replacement part numbers, refer to the *Parts Manual* or call your Vermeer dealer.

Service	Maintenance Interval - Service Hours							As Required
	5 or 2x Daily	10 or Daily	50 or Weekly	100	250	500	1000	
Trencher End Idler - Grease	●							
Porta Bore Water Jacket (Option) - Grease	●							
Porta Bore Mounting Bracket - Check	●							
Engine Air Intake Screen - Clean		●						
Engine Oil Level - Check		●						
Air Cleaner Restriction Indicator - Check		●						
Hydraulic Fluid Level - Check		●						
Fuel Tank - Fill		●						
Cooling System - Check		●						
Backhoe - Grease		●						
Trencher Boomhead Pivots - Grease		●						
Trencher Auger Bearings - Grease		●						
Hydraulic Trench Cleaner (Option) Cylinder - Grease		●						
End Idler Side Play - Check		●						
Plow - Grease		●						
Plow Shaker Gearbox and Bearing Housing Oil Level - Check		●						
Porta Bore Drive - Grease		●						

Service	Maintenance Interval - Service Hours							
	5 or 2x Daily	10 or Daily	50 or Weekly	100	250	500	1000	As Required
Engine Oil and Filter - Change/Replace			Initial					
Fuel Filter - Replace			Initial					
Valve Clearance - Check			Initial					
Blower Belt Tension - Check			Initial					
Hydraulic Fluid Filter - Replace			Initial					
Axle Driveline - Grease			●					
Axle Pivot - Grease			●					
Axle Spindles - Grease			●					
Control Pedal - Grease			●					
Ground Drive Linkage - Grease			●					
Control Levers Linkage - Oil			●					
Backfill Blade - Grease			●					
Backhoe Swing Pivot Chain - Oil			●					
Trencher Boom Tightener Grease Tube - Grease			●					
Trencher Slide Frame (Option) Wear Pads and Bolts - Check			●					
Shaker Box Oil - Change			Initial					
Plow Blade Condition - Check			●					
Tamping Wheels - Check			●					
Sod Cutter Condition - Check			●					
Safety Signs Maintenance				●				
Control Levers - Check				●				
Hydraulic Fluid Filter - Replace				●				
Overall Machine and Attachments - Check				●				

Service	Maintenance Interval - Service Hours							As Required
	5 or 2x Daily	10 or Daily	50 or Weekly	100	250	500	1000	
Tires and Rims - Check				•				
Neutral Start Interlock - Check				•				
Hydraulic Systems - Check				•				
Park Brake - Check/Adjust				•				
Service Brake - Check				•				
Indicator Lights - Check				•				
Hydraulic Oil Cooler - Clean				•				
Seat Belts - Clean/Inspect				•				
Operator Presence System - Check				•				
Backhoe - Check				•				
Backhoe Remote Creep - Check				•				
Backhoe Stabilizer - Check				•				
Backhoe Remote Stop - Check				•				
Backhoe Neutral Start Interlock - Check				•				
Backhoe Operator Presence System - Check				•				
Backhoe Hydraulic Components - Check				•				
Trencher Components - Check				•				
Trencher Digging Chain - Check				•				
Trencher Hydraulic Components - Check				•				
Trencher Digging Chain Control - Check				•				
Trencher Attachment - Overall Check				•				
Plow Attachment - Overall Check				•				
Plow Hydraulic Components - Check				•				
Plow Control - Check				•				

**Maintenance Interval - Service Hours**

Service	Maintenance Interval - Service Hours							
	5 or 2x Daily	10 or Daily	50 or Weekly	100	250	500	1000	As Required
Reel Carrier Hydraulic Components - Check				•				
Engine Oil Cooler - Clean					•			
Engine Oil and Filter - Change and Replace					•			
Axle Oil - Check/Initial Change					Initial			
Valve Clearance - Adjust								
Blower Belt Tension - Check						•		
Fuel Filter - Replace						•		
Battery Electrolyte Levels and Terminals - Check						•		
Plow Shaker Gearbox Oil/Shaker Bearing Housing Oil - Change						•		
Hydraulic Fluid - Change								
Axle Oil - Change							•	
Engine - Check							•	
Control Lever Tension - Adjust								•
Air Cleaner Element - Replace								•
Battery - Replace								•
Rollover Protection Structure - Check								•
Highway Lights (Option) - Replace								•
Backhoe Bucket Teeth - Replace								•
Backhoe Bucket - Replace								•
Digger Drive Sprocket - Reverse/Replace								•
Wearstrip - Maintain								•
Digging Chain - Maintain/Adjust/Remove/Install								•
Digging Chain Wear - Check								•

Service	Maintenance Interval - Service Hours							As Required
	5 or 2x Daily	10 or Daily	50 or Weekly	100	250	500	1000	
Digging Chain - Remove Portion								●
Cutters - Replace								●
Base Plates - Replace								●
End Idler - Remove								●
Trench Cleaner (Option) Bridge/Restraint Bar - Adjust								●
Augers - Maintain								●
Slide Frame (Option) Wear Pads - Adjust/Maintain								●
Porta Bore Components - Clean								●
Storage								●

Provided for Free by Trenchwell.com  
Shop Aftermarket Parts

This page intentionally left blank.

## Index

### A

### B

Backfill Blade Controls, 35-1  
Backfill Blade Operation, 35-3  
Backfill Blade, 35-1  
Backfilling, 35-4  
Backhoe Controls, 40-1  
Backhoe Load Capacity - Model B450, 40-12  
Backhoe Operation, 40-13  
Backhoe Safety, 40-9  
Backhoe Transport Locks, 40-5  
Backhoe, 40-1  
Backreaming, 55-11  
Battery Burns - Avoid, 22-6  
Battery Explosion - Avoid, 22-5  
Boring Attachment and Shield - Check, 55-4

### C

Call Your One-Call System First, 30-6  
Carry Reels Only, 60-3  
Chain Speed - Set, 45-8  
Cold Weather Starting, 22-3  
Completing the Trench, 45-14  
Counterweight Requirements, 5-1  
Crystalline Silica, 45-6  
Cutting Head - Guide, 55-7  
Cutting Tool - Change, 55-11

RT450 Tractor/Attachments

### D

Dealer Prep, i  
Dealer/Customer Information, v  
Delivery, iv  
Digging Conditions, 45-9  
Digging Procedure, 40-15  
Do Not Allow Drill Rod to Whip, 55-3  
Drill Rod - Remove, 55-12  
Drill Rod Grade - Check, 55-9  
Drill Rod Safety, 55-2  
Driving the Machine, 25-4  
Dual Operation of Controls, 40-13

### E

Electricity, 30-7  
Engine Controls, 20-1  
Engine Start and Stop, 40-7  
Ether Cold Starting System (Option), 22-3

### F

Fiber Optic, 30-8  
Finishing, 40-16  
Fire Extinguisher Mounting Location, 20-11

### G

Gas, 30-8  
Ground Drive and Brake Controls, 20-6  
Guide Stakes, 55-10

## **H**

Hourmeter - Check for Maintenance Interval, 65-2  
Hydraulic Bypass System, 22-4  
Hydraulic Controls, 20-8

## **I**

Identification Numbers - Record, vi  
Indicators, 20-3  
Intended Use, 15-1

## **J**

Jobsite Assessment, 30-8  
Jump-Starting Procedure, 22-6  
Jump-Starting, 22-5

## **K**

## **L**

Lifting the Machine, 25-8  
Load Reel, 60-4  
Loading the Machine, 25-5  
Locate Buried Utilities, 30-6  
Look for Evidence of Underground Placement, 30-7

## **M**

Machine - Grease, 65-2  
Machine - Set Up for Boring, 55-6  
Machine Counterweights, 60-2  
Maintenance Intervals, 65-3  
Maintenance Manual, 65-2  
Maintenance Schedule, 65-1

## **Index**

Manual Fold, 45-3

Motor Direction - Reverse, 55-9

Mount and Dismount Safely, 25-3

## **N**

No Riders in Backhoe Seat, 40-11

## **O**

Offset Plowing Position, 50-12

Opening a Trench, 40-14

Operating the Backhoe, 40-9

Operating the Plow, 50-6

Operating the Reel Carrier, 60-2

Operating the Trencher, 45-3

Operation - Check, 55-9

Operator Presence Switch - Check, 30-1

Operator Presence Switch, 20-9

Operator Qualifications, 30-1

Overriding Creep Lever, 45-14

## **P**

Personal Protection, 30-4

Plow Blade - Install, 50-4

Plow Controls, 50-1

Plow Safety, 50-6

Plow Transport Lock, 50-3

Plow, 50-1

Plowing - Continue, 50-9

Plowing - Start with Bell Hole or Trench, 50-7

Plowing - Start without Bell Hole or Trench, 50-8

Plowing - Stop with Bell Hole, 50-13

Plowing - Stop without Bell Hole, 50-13  
Plowing Tips, 50-6  
Porta Bore Controls, 55-1  
Porta Bore Operation, 55-1  
Porta Bore Safety, 55-1  
Porta Bore Transport/Stow, 55-13  
Porta Bore, 55-1  
Prepare the Area, 30-5  
Prepare the Machine, 30-10  
Preparing the Machine and Work Area, 30-1

## **Q**

## **R**

Reaming - Start, 55-12  
Receiving and Delivery Report, i  
Reel Carrier - Hydraulic Attachment, 60-3  
Reel Carrier Controls, 60-1  
Reel Carrier Safety, 60-2  
Reel Carrier, 60-1  
Remote Creep (Option), 40-16  
Retrieval, 25-8  
Rod- Install Additional, 55-10  
Rollover Can Crush, 40-10  
Rollover Protective Structure (ROPS), 30-2

## **S**

Safety Messages, 10-1  
Safety Signs, 65-1  
Safety Symbol Explanation, 10-1  
Seat Adjustments, 20-10  
Seat Assembly, 40-8

## **RT450 Tractor/Attachments**

Seat Belt, 20-9, 30-3  
Shaft Angle - Limit, 55-5  
Shaker Speed - Set, 50-10  
Shutdown Procedure, 23-1  
Sod Cutter (Option), 50-3  
Sound and Vibration Levels, 30-5  
Start Boring, 55-8  
Starting Procedure, 22-1  
Starting the Engine, 22-2  
Starting the Trench, 45-11  
Steering, 50-11  
Striking a Utility, 30-7

## **T**

Thrown Wrench, 55-2  
Towing the Machine, 25-7  
Tractor Controls, 20-1  
Trailing the Machine, 25-5  
Transportation Safety, 25-1  
Transporting the Machine, 25-1  
Transporting, 40-11  
Trench - Set Up, 55-5  
Trench Cleaner - Manual (Option), 45-3  
Trench Cleaner Assembly (Option)/Restraint Bar, 45-10  
Trencher Controls, 45-1  
Trencher Safety, 45-3  
Trencher, 45-1  
Trenching Tips, 45-7  
Trenching, 45-10

## **U**

Universal Joint - Remove, 55-10  
Unloading the Machine, 25-7  
Use Two People for Porta Bore Operation, 55-5

**V**  
**W**

Warning Beacon Mounting Location, 20-11  
Water Jacket (Option), 55-11  
With Hanger Holes, 50-5  
Without Hanger Holes, 50-4  
Work Area - Check/Clear, 55-3