

**Genie Industries**



# Genie GS-1530 Genie GS-1930

## **Service Manual**

*(before serial number 17408)*

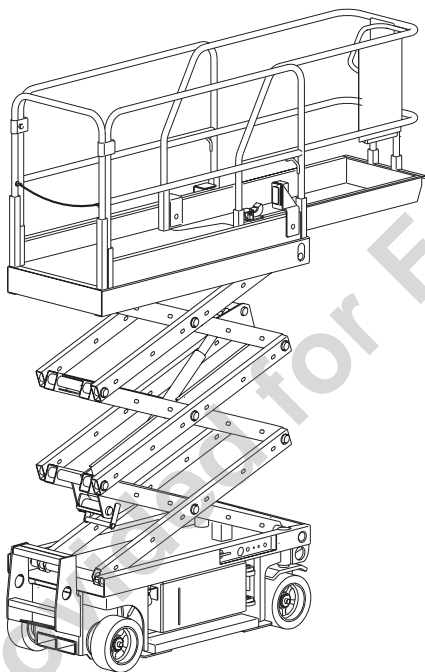

First Edition, Third Printing  
Rev C2  
Part No. 39528



# Genie GS-1530

# Genie GS-1930

## Important

Read, understand and obey the safety rules and operating instructions in the appropriate *Genie GS-1530 & Genie GS-1930 Operator's Manual* before attempting any maintenance or repair procedure.

This manual provides detailed scheduled maintenance information for the machine owner and user. It also provides troubleshooting and repair procedures for qualified service professionals.

Basic mechanical, hydraulic and electrical skills are required to perform most procedures. However, several procedures require specialized skills, tools, lifting equipment and a suitable workshop. In these instances, we strongly recommend that maintenance and repair be performed at an authorized Genie dealer service center.

Genie Industries has endeavored to deliver the highest degree of accuracy possible. However, continuous improvement of our products is a Genie policy. Therefore, product specifications are subject to change without notice.

Readers are encouraged to notify Genie of errors and send in suggestions for improvement. All communications will be carefully considered for future printings of this and other manuals. Please write to the technical publications team in care of Genie Industries, PO Box 97030, Redmond WA 98073-9730 USA.

If you have any questions, please call Genie Industries.

## Genie North America

Telephone (425) 881-1800  
Toll Free in U.S.A. 800 536-1800  
Toll Free in Canada 800 426-8089  
Fax (425) 882-9260  
E-mail: techpub@genieind.com  
<http://www.genielift.com>

## Genie Europe

Office Telephone (44) 01636-605030  
Office Fax (44) 01636-611090  
Parts Telephone (44) 01636-605002  
Parts Fax (44) 01636-611091

## Genie Industries

Copyright © 1997 by Genie Industries

First Edition:      First Printing August, 1997  
                            Second Printing February, 1998  
                            Third Printing September, 1999

"Genie" is a registered trademark of Genie Industries in the U.S.A. and many other countries. "GS" is a trademark of Genie Industries.

These machines comply with ANSI/SIA 92.6-1990.

 Printed on recycled paper

Printed in U.S.A.

# Safety Rules



## **Danger**

Failure to obey the instructions and safety rules in this manual and the appropriate *Genie GS-1530 & Genie GS-1930 Operator's Manual* will result in death or serious injury.

Many of the hazards identified in the operator's manual are also safety hazards when maintenance and repair procedures are performed.

## **Do Not Perform Maintenance Unless:**

- You are trained and qualified to perform maintenance on this machine.
- You read, understand and obey:
  - manufacturer's instructions and safety rules
  - employer's safety rules and worksite regulations
  - applicable governmental regulations
- You have the appropriate tools, lifting equipment and a suitable workshop.

## SAFETY RULES

**Personal Safety**

Any person working on or around a machine must be aware of all known safety hazards. Personal safety and the continued safe operation of the machine should be your top priority.



Read each procedure thoroughly. This manual and the decals on the machine use signal words to identify the following:



Safety alert symbol—used to alert personnel to potential personal injury hazards. Obey all safety messages that follow this symbol to avoid possible injury or death.

**▲ DANGER**

Red—used to indicate the presence of an imminently hazardous situation which, if not avoided, will result in death or serious injury.

**▲ WARNING**

Orange—used to indicate the presence of a potentially hazardous situation which, if not avoided, could result in death or serious injury.

**▲ CAUTION**

Yellow with safety alert symbol—used to indicate the presence of a potentially hazardous situation which, if not avoided, may cause minor or moderate injury.

**CAUTION**

Yellow without safety alert symbol—used to indicate the presence of a potentially hazardous situation which, if not avoided, may result in property damage.

**NOTICE**

Green—used to indicate operation or maintenance information.

Be sure to wear protective eye wear and other



protective clothing if the situation warrants it.



Be aware of potential crushing hazards such as moving parts and free swinging or unsecured components when lifting or placing loads. Always wear approved steel-toed shoes.

**Workplace Safety**

Be sure to keep sparks, flames and lighted tobacco away from flammable and combustible materials such as battery gases and engine fuels. Always have an approved fire extinguisher within easy reach.



Be sure that all tools and working areas are properly maintained and ready for use. Keep work surfaces clean and free of debris that could get into machine components and cause damage.



Be sure that your workshop or work area is properly ventilated and well lit.



Be sure any forklift, overhead crane or other lifting or supporting device is fully capable of supporting and stabilizing the weight to be lifted. Use only chains or straps that are in good condition and of ample capacity.



Be sure that fasteners intended for one time use (i.e., cotter pins and self-locking nuts) are not reused. These components may fail if they are used a second time.



Be sure to properly dispose of old oil or other fluids. Use an approved container. Please be environmentally safe .



# Theory of Operation

## Power Source

The Genie GS-1530 and GS-1930 machines are powered by four six-volt (255 AH) batteries. The four batteries are wired in series to produce 24 volts.

## Hydraulic System

All machine functions are performed by the hydraulic system. The hydraulic system is powered by a single-section gear pump. When the pump is activated, it supplies hydraulic fluid under pressure to the function manifold, where the control valves are located. To protect from over-pressurization of the hydraulic system, the pump is provided with a pressure relief valve.

Activating a machine function is accomplished by actuating or moving a switch and/or control handle, which sends voltage to the ECM. The ECM then sends the signal to the appropriate directional control valve. The directional valve determines which direction the hydraulic fluid will travel. Computer software determines the volume of fluid in relation to the proportional valve input voltage.

## Electrical System

Limit switches are found in various locations on the machine. The function of a limit switch is to communicate the operating position of the machine to the ECM (Electronic Control Module). When a change in signal is received from a limit switch, the ECM responds by limiting the drive speed to 0.5 miles per hour (0.8 km/h), according to the default settings in the ECM software.

## Machine Controls

The GS-1530 and GS-1930 machines are equipped with operational controls which are found in two locations: the ground controls, located on the hydraulic tank side of the machine, and the platform controls, located in the platform. All lift and drive functions are available at the platform controls. Only platform up/down functions are available at the ground controls.

The ECM uses input from the ground or platform

controls to activate the various machine functions. The ECM has predetermined settings for the various machine functions.

The joystick is fitted with a 5000 ohm potentiometer. With the joystick in the neutral position, the potentiometer will measure 2730 ohms. These signals are sent to the multiplex card, then down to the ECM to control the voltage supplied to the proportional valve. Two microswitches mounted on the joystick tell the ECM the drive direction desired. A thumb rocker switch on the top of the joystick is used for steering.

Mounted on the platform control box lid of machines before serial number 17408 are buttons and a switch that, when activated, sends a signal to the ECM through the multiplex card. On machines after serial number 17407, the platform control box lid has a decal/membrane pad. This is a touch-activated pad incorporating wiring, switches and LEDs that are resistant to the environment. Activating any of the buttons on the pad will send a signal to the ECM through the multiplex card.

A diagnostic display is located at the battery pack side of the machine to aid in troubleshooting. If the machine malfunctions, a fault code will be shown in the display window.

Washing electronic components is not suggested. Instead, use compressed air to remove debris from these components.

**⚠ CAUTION** Component damage hazard. Avoid shock or impact to the ECM. Internal damage may not be visible from the outside.

# Table of Contents

## Introduction

Important Information .....	<i>ii</i>
-----------------------------	-----------

## Section One Safety Rules

General Safety Rules .....	<i>iii</i>
Theory of Operation .....	<i>v</i>

## Section Two Rev Specifications

D Machine Specifications .....	2 - 1
D Performance Specifications .....	2 - 2
D Hydraulic Specifications .....	2 - 2
D Hydraulic Hose and Fitting Torque Specifications .....	2 - 3

## Section Three Scheduled Maintenance Inspections

Introduction .....	3 - 1
Table A .....	3 - 2
Table B .....	3 - 2
Table C .....	3 - 3
Table D .....	3 - 3
Maintenance Inspection Report .....	3 - 4

## Section Four Scheduled Maintenance Procedures

Introduction .....	4 - 1
A-1 Inspect the Operator's and Safety Manuals .....	4 - 2
A-2 Inspect the Decals and Placards .....	4 - 2
A-3 Inspect for Damage and Loose or Missing Parts .....	4 - 3
A-4 Check the Hydraulic Oil Level .....	4 - 3
A-5 Check for Hydraulic Leaks .....	4 - 4
A-6 Test the Platform and Ground Controls .....	4 - 4
A-7 Test the Manual Platform Lowering Operation .....	4 - 5
A-8 Test the Tilt Sensor .....	4 - 6
A-9 Test the Pothole Guards .....	4 - 6
A-10 Test the Lift/Drive Select Switch (before serial number 17408) .....	4 - 7
A-11 Perform 30 Day Service .....	4 - 7

---

<b>Section Four</b>	<b>Scheduled Maintenance Procedures, continued</b>	
B-1	Check the Batteries .....	4 - 8
B-2	Inspect the Electrical Wiring .....	4 - 9
B-3	Inspect the Tires and Wheels (including castle nut torque) .....	4 - 10
B-4	Test the Key Switch .....	4 - 10
B-5	Test the Emergency Stop Buttons .....	4 - 11
B-6	Test the Service Horn .....	4 - 11
B-7	Test the Drive Brakes .....	4 - 12
B-8	Test the Drive Speed - Stowed Position .....	4 - 14
B-9	Test the Drive Speed - Raised Position .....	4 - 14
B-10	Perform Hydraulic Oil Analysis .....	4 - 15
B-11	Check the Electrical Contactor (before serial number 6901) .....	4 - 15
C-1	Replace the Hydraulic Filter .....	4 - 16
D-1	Test or Replace the Hydraulic Oil .....	4 - 17

## TABLE OF CONTENTS

**Section Five Troubleshooting Flow Charts and Fault Codes**

Chart Number	Chart Title	Page
	Introduction .....	5 - 1
	Fault Code Chart Before Serial Number 17408 .....	5 - 3
	Normal Operation Code Chart .....	5 - 6
	Fault Code Chart After Serial Number 17407 .....	5 - 8
1	All Functions Will Not Operate .....	5 - 9
2	Pump Motor Will Not Operate .....	5 - 12
3	All Functions Inoperative, Power Unit Starts and Runs .....	5 - 14
4	Ground Controls Inoperative, Platform Controls Operate Normally .....	5 - 15
5	Platform Controls Inoperative, Ground Controls Operate Normally .....	5 - 16
6	Platform Up Function Inoperative .....	5 - 18
7	Platform Down Function Inoperative .....	5 - 19
8	Steer Left Function Inoperative .....	5 - 21
9	Steer Right Function Inoperative .....	5 - 23
10	All Drive Functions Inoperative, All Other Functions Operate Normally .....	5 - 25
10A	Brake Release Function Inoperative .....	5 - 27
11	Drive Forward Function Inoperative .....	5 - 28
12	Drive Reverse Function Inoperative .....	5 - 29
13	Machine Will Not Drive At Full Speed .....	5 - 30
14	Machine Drives At Full Speed With Platform Raised .....	5 - 32

TABLE OF CONTENTS

---

<b>Section Six</b>	<b>Schematics</b>	
	Introduction .....	6 - 1
	Electrical Components .....	6 - 2
	Module Tray Legend .....	6 - 3
	Electrical Symbols Legend .....	6 - 4
	Electrical Schematic (models before serial number 6901) .....	6 - 5
	Electrical Schematic (models from serial number 6901 to 8931) .....	6 - 7
	Electrical Schematic (models after serial number 8931) .....	6 - 9
	Ground Controls and Level Sensor Box Legend .....	6 - 11
	Platform Controls Legend (models before serial number 17408) .....	6 - 12
	Platform Controls Legend (models after serial number 17407) .....	6 - 13
	Hydraulic Symbols Legend .....	6 - 14
	Hydraulic Schematic .....	6 - 15

## TABLE OF CONTENTS

<b>Section Seven</b>	<b>Repair Procedures</b>	
	Introduction .....	7 - 1
	<b>Platform Controls</b>	
1-1	Platform Controller .....	7 - 2
1-2	Software Configuration .....	7 - 3
1-3	Toggle Switches .....	7 - 6
	<b>Platform Components</b>	
2-1	Platform .....	7 - 8
2-2	Platform Extension .....	7 - 9
	<b>Scissor Components</b>	
3-1	Scissor Assembly, GS-1530 (machines before serial number 632) .....	7 - 10
3-2	Scissor Assembly, GS-1930 (machines before serial number 632) .....	7 - 16
3-3	Scissor Assembly, GS-1530 (machines after serial number 631) .....	7 - 22
3-4	Scissor Assembly, GS-1930 (machines after serial number 631) .....	7 - 28
3-3	Lift Cylinder .....	7 - 34
	<b>Ground Controls</b>	
4-1	Manual Platform Lowering Cable .....	7 - 36
4-2	Toggle Switches, See 1-3, <i>Toggle Switches</i> .....	7 - 6
	<b>Hydraulic Pump</b>	
5-1	Function Pump .....	7 - 37
	<b>Manifolds</b>	
6-1	Function Manifold Components .....	7 - 38
6-2	Valve Adjustment - Function Manifold .....	7 - 40
	<b>Steering Axle Components</b>	
7-1	Yoke and Drive Motor .....	7 - 42
7-2	Steering Cylinder .....	7 - 43
7-3	Steering Bellcrank (machines before serial number 2000) .....	7 - 44
7-4	Steering Bellcrank (machines after serial number 1999) .....	7 - 44
	<b>Non-steering Axle Components</b>	
8-1	Drive Brake .....	7 - 45
	<b>Brake Release Hand Pump Components</b>	
9-1	Brake Release Hand Pump .....	7 - 46

# Specifications

REV D

## Machine Specifications

Model	GS-1530	GS-1930
<b>Stowed dimensions</b>		
Length	72 in 183 cm	72 in 183 cm
Length, platform extended	101 <sup>1</sup> / <sub>2</sub> in 257.8 cm	101 <sup>1</sup> / <sub>2</sub> in 257.8 cm
Width	30 in 76.2 cm	30 in 76.2 cm
Height, stowed maximum Rails up - CE	80 <sup>1</sup> / <sub>4</sub> 203.7 cm	82 <sup>1</sup> / <sub>2</sub> 209.6 cm
Height, stowed maximum Rails up - ANSI	75 <sup>7</sup> / <sub>8</sub> in 192.8 cm	78 <sup>1</sup> / <sub>4</sub> in 198.6 cm
Height, stowed maximum Rails lowered	74 in 188 cm	76 <sup>5</sup> / <sub>16</sub> in 193.8 cm
Height, stowed maximum rails removed	36 <sup>1</sup> / <sub>2</sub> in 93 cm	38 <sup>1</sup> / <sub>2</sub> in 98 cm
Height, guard rail level	40 in 102 cm	40 in 102 cm
Weight	2563 lbs 1163 kg	2963 lbs 1344 kg
Ground clearance	2 <sup>7</sup> / <sub>8</sub> 6.8 cm	2 <sup>7</sup> / <sub>8</sub> 6.8 cm
Ground clearance Pothole guards deployed	<sup>7</sup> / <sub>8</sub> in 2.2 cm	<sup>7</sup> / <sub>8</sub> in 2.2 cm

**Continuous improvement of our products is a Genie policy. Product specifications are subject to change without notice.**

## Operational dimensions

Maximum platform height	15 ft 4.6 m	19 ft 5.8 m
Maximum platform working height	21 ft 6.4 m	25.1 ft 7.7 m
Maximum platform extension	39 <sup>1</sup> / <sub>4</sub> in 1 m	39 <sup>1</sup> / <sub>4</sub> in 1 m
Wheelbase	52 in 132.1 cm	52 in 132.1 cm
Turning radius, outside	61 in 154.9 cm	61 in 154.9 cm
Turning radius, inside	0 in 0 cm	0 in 0 cm

## Tires and wheels

Tire size (solid rubber)	12 x 4.5 x 8.6 in 30.5 x 11.4 x 21.8 cm	
Load range	2,400 lbs 1,089 kg	
Tire contact area	9 sq in	58 sq cm
Overall tire diameter	12 in	30.5 cm
Wheel diameter	8.6 in	21.8 cm
Wheel width	4.5 in	11.4 cm
Castle nut torque	300 ft-lbs	406.7 Nm

## Platform dimensions

Length	62 <sup>1</sup> / <sub>4</sub> in	158 cm
Width	25 <sup>1</sup> / <sub>2</sub> in	65 cm
Extension length	29 <sup>1</sup> / <sub>2</sub> in	74.9 cm
Maximum load capacity	600 lbs 272 kg	500 lbs 227 kg

## Fluid Capacities

Hydraulic tank capacity	5 gallons	18.9 liters
Hydraulic system capacity (including tank)	5 <sup>1</sup> / <sub>2</sub> gallons	20.8 liters

## SPECIFICATIONS

REV D

**Performance Specifications**

Model	GS-1530	GS-1930
<b>Drive speeds (maximum)</b>		
Stowed, maximum	2.5 mph 40 ft / 10.7 sec	4 km/h 12.2 m / 10.7 sec
Platform raised, maximum	0.5 mph 40 ft / 55 sec	0.7 km/h 12.2 m / 55 sec
<b>Gradeability</b>		
GS-1530		30%
GS-1930		30%
<b>Function speed, maximum from platform controls</b>		
Platform up	16 to 18 seconds	16 to 18 seconds
Platform down	16 to 17 seconds	22 to 23 seconds

**Hydraulic Specifications**

Hydraulic fluid	Dexron equivalent	
<b>Lift pump</b>		
Type: gear		
Displacement per revolution	.244 cu in 4 cc	
Displacement	4 gallons per minute 15 liters per minute (2500 psi/172 bar)	
Hydraulic tank return line filter	10 micron with 25 psi (1.7 bar) bypass	
<b>Function manifold</b>		
<b>Model</b>	<b>GS-1530</b>	<b>GS-1930</b>
System relief valve pressure		
GS-1530	3000 psi	207 bar
GS-1930	3500 psi	241 bar
Steer relief valve pressure	1200 psi	82.8 bar

REV D

SPECIFICATIONS

## Hydraulic Hose and Fitting Torque Specifications

Your machine is equipped with either 37° flared fittings and hose ends OR Parker Seal-Lok® fittings and hose ends. Machines that utilize Parker Seal-Lok® hoses and fittings require that the fittings and hose ends be torqued to specification when they are removed and installed or when new hoses or fittings are installed. Machines equipped with 37° flared fittings and hose ends do not need to be torqued to these specifications.

Hydraulic Hose and Fitting Torque Specifications						
SAE O-ring Boss Port - tube fitting				Seal-Lok® - hose end		
SAE Dash Size	Installing into...	ft. lbs.	Nm	SAE Dash Size	ft. lbs.	Nm
-4	Aluminum	11	14.9	-4	18	24.4
	Steel	16	21.7	-6	27	36.6
-6	Aluminum	23	31.2	-8	40	54.2
	Steel	35	47.5	-10	63	85.4
-8	Aluminum	40	54.2	-12	90	122
	Steel	60	81.3	-16	120	162.7
-10	Aluminum	69	93.6	-20	140	190
	Steel	105	142.4	-24	165	223.7
-12	Aluminum	93	126.1			
	Steel	140	190			
-16	Aluminum	139	188.5			
	Steel	210	284.7			
-20	Aluminum	172	233.2			
	Steel	260	352.5			
-24	Aluminum	208	282			
	Steel	315	427.1			

## Torque Procedure

- 1 Replace the O-ring. The O-ring must be replaced anytime the seal has been broken. The O-ring cannot be re-used if the fitting or hose end has been tightened beyond finger tight.
- 2 Lubricate the O-ring before installation.
- 3 Be sure that the face seal O-ring is seated and retained properly.
- 4 Position the tube and nut squarely on the face seal end of the fitting and tighten the nut finger tight.
- 5 Tighten the nut or fitting to the appropriate torque per given size as shown in the table above.
- 6 Operate all machine functions and inspect the

### NOTICE

The O-rings used in the Parker Seal Lok® fittings and hose ends are a custom-size O-ring. They are not a standard SAE size O-ring. They are available in the O-ring field service kit (Genie part number 49612).

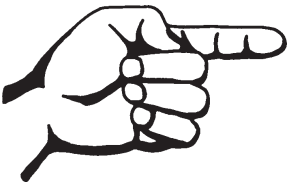

This page intentionally left blank.

Provided for Free by Trenchwell.com  
Shop Aftermarket Parts

# Scheduled Maintenance Inspections



## Observe and Obey:

- ☑ Maintenance inspections shall be completed by a person trained and qualified on the maintenance of this machine.
- ☑ Scheduled maintenance inspections shall be completed daily, quarterly, annually and every 2 years as specified on the *Maintenance Inspection Report*.

**⚠WARNING** Failure to properly complete each inspection when required may cause death, serious injury or substantial machine damage.

- ☑ Immediately tag and remove from service a damaged or malfunctioning machine.
- ☑ Repair any machine damage or malfunction before operating machine.
- ☑ Keep records on all inspections for three years.
- ☑ Machines that have been out of service for a period longer than 3 months must complete the quarterly inspection.

## About This Section

### The Schedule

There are four types of maintenance inspections that must be performed according to a schedule—daily, quarterly, annual and two year. To account for repeated procedures, the *Maintenance Tables* and the *Maintenance Inspection Report* have been divided into four subsections—A, B, C, D. Use the following chart to determine which group(s) of procedures are required to perform a scheduled inspection.

Inspection	Table or Checklist
Daily	A
Quarterly	A + B
Annual	A + B + C
Two year	A + B + C + D

### Maintenance Tables

The maintenance tables contained in this section provide summary information on the specific physical requirements for each inspection.

Complete step-by-step instructions for each scheduled maintenance procedure are provided in section 4, *Scheduled Maintenance Procedures*.







### Maintenance Inspection Report

The maintenance inspection report contains checklists for each type of scheduled inspection.





Make copies of the *Maintenance Inspection Report* to use for each inspection. Store completed forms for three years.

# Maintenance Tables

**Table A**







		Tools are required	New parts required	Dealer service suggested
A-1	Inspect the Operator's and Safety Manuals			
A-2	Inspect the Decals and Placards			
A-3	Inspect for Damage, Loose or Missing Parts			
A-4	Check the Hydraulic Oil Level			
A-5	Check for Hydraulic Leaks			
A-6	Test the Platform and Ground Controls			
A-7	Test the Manual Platform Lowering Operation			
A-8	Test the Tilt Sensor			
A-9	Test the Pothole Guards			
A-10	Test the Lift/Drive Select Switch (before serial number 17408)			
A-11	Perform 30 Day Service			

**Table B**

B-1	Check the Batteries			
B-2	Inspect the Electrical Wiring			
B-3	Inspect the Tires and Wheels (including castle nut torque)			
B-4	Test the Key Switch			

MAINTENANCE TABLES

**Table B, continued**

		Tools are required	New parts required	Dealer service suggested
B-5	Test the Emergency Stop Buttons			
B-6	Test the Horn			
B-7	Test the Drive Brakes			
B-8	Test the Drive Speed - Stowed Position			
B-9	Test the Drive Speed - Raised Position			
B-10	Perform Hydraulic Oil Analysis See D-1 <i>Test or Replace the Hydraulic Oil</i>			
B-11	Check the Electrical Contactor (before serial number 6901)			

**Table C**

C-1	Replace the Hydraulic Filter			
-----	------------------------------	---	--	--

**Table D**

D-1	Test or Replace the Hydraulic Oil			
-----	-----------------------------------	---	--	---

# Maintenance Inspection Report

**Model** \_\_\_\_\_

**Serial number** \_\_\_\_\_

**Date** \_\_\_\_\_

**Hour meter** \_\_\_\_\_

**Machine owner** \_\_\_\_\_

**Inspected by (print)** \_\_\_\_\_

**Inspector signature** \_\_\_\_\_

**Inspector title** \_\_\_\_\_

**Inspector company** \_\_\_\_\_

**Instructions**

- Make copies of this page to use for each inspection.
- Select the appropriate checklist(s) for the type of inspection to be performed.

- Daily Inspection: A**
- Quarterly Inspection: A+B**
- Annual Inspection: A+B+C**
- 2 Year Inspection: A+B+C+D**

- Place a check in the appropriate box after each inspection procedure is completed.
- Use the maintenance tables in this section and the step-by-step procedures in section 4 to learn how to perform these inspections.
- If any inspection receives an "N," tag and remove the machine from service, repair and re-inspect it. After repair, place a check in the "R" box.

**Legend**

- Y = yes, acceptable
- N = no, remove from service
- R = repaired

**Comments** \_\_\_\_\_

<b>Checklist A</b>	<b>Y</b>	<b>N</b>	<b>R</b>
Refer to Table A			
A-1 Operator's and Safety manuals			
A-2 Decals and placards			
A-3 Damage, loose or missing parts			
A-4 Hydraulic oil level			
A-5 Hydraulic leaks			
A-6 Platform and ground controls			
A-7 Manual Platform Lowering			
A-8 Tilt sensor			
A-9 Pothole Guards			
A-10 Lift/drive Select Switch (before serial number 17408)			
A-11 30 Day Service			

<b>Checklist B</b>	<b>Y</b>	<b>N</b>	<b>R</b>
Refer to Table B			
B-1 Batteries			
B-2 Electrical wiring			
B-3 Tires and wheels			
B-4 Key Switch			
B-5 Emergency Stop			
B-6 Horn			
B-7 Drive Brakes			
B-8 Drive speed - stowed			
B-9 Drive speed - raised			
B-10 Hydraulic oil analysis			
B-11 Electrical contactor (before serial number 6901)			

<b>Checklist C</b>	<b>Y</b>	<b>N</b>	<b>R</b>
Refer to Table C			
C-6 Hydraulic filter			

<b>Checklist D</b>	<b>Y</b>	<b>N</b>	<b>R</b>
Refer to Table D			
D-1 Hydraulic oil			

# Scheduled Maintenance Procedures



## Observe and Obey:

- ☑ Maintenance inspections shall be completed by a person trained and qualified on the maintenance of this machine.
- ☑ Scheduled maintenance inspections shall be completed daily, quarterly, annually and every 2 years as specified on the *Maintenance Inspection Report*.

**AWARNING** Failure to properly complete each inspection when required may cause death, serious injury or substantial machine damage.

- ☑ Immediately tag and remove from service a damaged or malfunctioning machine.
- ☑ Repair any machine damage or malfunction before operating machine.
- ☑ Keep records on all inspections for three years.
- ☑ Unless otherwise specified, perform each procedure with the machine in the following configuration:
  - Machine parked on a flat level surface
  - Platform in the stowed position
  - Key switch in the OFF position with the key removed
  - Wheels chocked

## About This Section

This section contains detailed procedures for each scheduled maintenance inspection.

Each procedure includes a description, safety warnings and step-by-step instructions.

### Symbols Legend



Safety alert symbol—used to alert personnel to potential personal injury hazards. Obey all safety messages that follow this symbol to avoid possible injury or death.

#### **DANGER**

Red—used to indicate the presence of an imminently hazardous situation which, if not avoided, will result in death or serious injury.

#### **AWARNING**

Orange—used to indicate the presence of a potentially hazardous situation which, if not avoided, could result in death or serious injury.

#### **CAUTION**

Yellow with safety alert symbol—used to indicate the presence of a potentially hazardous situation which, if not avoided, may cause minor or moderate injury.

#### **CAUTION**

Yellow without safety alert symbol—used to indicate the presence of a potentially hazardous situation which, if not avoided, may result in property damage.

#### **NOTICE**

Green—used to indicate operation or maintenance information.

- ⦿ Indicates that a specific result is expected after performing a series of steps.

# Table A Procedures

## A-1 Inspect the Operator's and Safety Manuals

Maintaining the operator's and safety manuals in good condition is essential to safe machine operation. Manuals are included with each machine and should be stored in the container provided in the platform. An illegible or missing manual will not provide safety and operational information necessary for a safe operating condition.

- 1 Check to be sure the storage container is present and in good condition.
- 2 Check to make sure that the operator's, responsibilities and safety manuals are present and complete in the storage container in the platform.
- 3 Examine the pages of each manual to be sure that they are legible and in good condition.
- 4 Always return the manuals to the storage container after use.

**NOTICE** Contact your authorized Genie distributor or Genie Industries if replacement manuals are needed.

## A-2 Inspect the Decals and Placards

Maintaining all of the safety and instructional decals and placards in good condition is mandatory for safe machine operation. Decals alert operators and personnel to the many possible hazards associated with using this machine. They also provide users with operation and maintenance information. An illegible decal will fail to alert personnel of a procedure or hazard and could result in unsafe operating conditions.

- 1 Refer to the *Decals* section in the appropriate *Genie GS-1530 & Genie GS-1930 Operator's Manual* and use the decal list and illustrations to determine that all decals and placards are in place.
- 2 Inspect all decals for legibility and damage. Replace any damaged or illegible decal immediately.

**NOTICE** Contact your authorized Genie distributor or Genie Industries if replacement decals are needed.

TABLE A PROCEDURES

### A-3 Inspect for Damage and Loose or Missing Parts

Daily machine condition inspections are essential to safe machine operation and good machine performance. Failure to locate and repair damage, and discover loose or missing parts may result in an unsafe operating condition.

- 1 Inspect the entire machine for damage and improperly installed or missing parts including:
  - Electrical components, wiring and electrical cables
  - Hydraulic power unit, tank, hoses, fittings, cylinders and manifolds
  - Drive motors
  - Pothole guards
  - Scissor pins and retaining fasteners
  - Scissor components and wear pads
  - Dents or damage to machine
  - Tires and wheels
  - Limit switches, level sensor and alarm
  - Optional horn (if equipped)
  - Beacons (if equipped)
  - Manual brake release components
  - Platform entry chain or gate
  - Safety arm
  - Cracks in welds or structural components
  - Battery pack and connections
  - Platform extension
  - Platform control joystick
  - Platform railings

### A-4 Check the Hydraulic Oil Level

Maintaining the hydraulic oil at the proper level is essential to machine operation. Improper hydraulic oil levels can damage hydraulic components. Daily checks allow the inspector to identify changes in oil level that might indicate the presence of hydraulic system problems.

**NOTICE** Perform this procedure with the platform in the stowed position.

- 1 Visually inspect the oil level in the hydraulic tank through the sight gauge in the side of the power unit module.
  - ⊙ Result: The hydraulic oil level should be within the FULL and ADD marks on the oil level indicator decal.
- 2 Add oil if necessary. Do not overfill.

#### Hydraulic Oil Specifications

Hydraulic oil type	Dexron equivalent
Hydraulic tank capacity	5.5 gallons 20.8 liters
Hydraulic system (including tank)	6 gallons 22.7 liters

TABLE A PROCEDURES

## A-5 Check for Hydraulic Leaks

Detecting hydraulic fluid leaks is essential to operational safety and good machine performance. Undiscovered leaks can develop into hazardous situations, impair machine functions and damage machine components.

- 1 Inspect for hydraulic oil puddles, dripping or residue on or around the following areas:
  - Hydraulic tank—filter, fittings and hoses
  - Hydraulic power unit, fittings and hoses
  - Hydraulic lift cylinder and manual lowering valve
  - Function manifold
  - The underside of the drive chassis
  - Drive motors
  - Drive brakes
  - Ground area under the machine

## A-6 Test the Platform and Ground Controls

Testing the machine functions and the Emergency Stop buttons for malfunctions is essential for safe machine operation. An unsafe working condition exists if any function fails to operate properly or either Emergency Stop button fails to stop all the machine functions. Each function should operate smoothly and be free of hesitation, jerking and unusual noise.

- 1 Turn the key switch to ground control and pull out the Emergency Stop button to the ON position at both the platform and ground controls.
- 2 Activate the platform up function.
  - ⊙ Result: The platform should raise.
- 3 Activate the platform down function.
  - ⊙ Result: The platform should lower. The descent alarm should sound while the platform is lowering.
- 4 Push in the ground controls Emergency Stop button to the OFF position.
  - ⊙ Result: No function should operate.
- 5 Turn the key switch to platform control and pull out the Emergency Stop button to the ON position at both the ground and the platform controls.
- 6 Press and hold the lift function enable button OR move the lift/drive selector switch to the lift position.
- 7 Press and hold the function enable switch on the control handle.
  - ⊙ Result: The green power light should come on.

TABLE A PROCEDURES

- 8 Slowly move the control handle in the direction indicated by the blue arrow.
- ⦿ Result: The platform should raise. The pothole guards should deploy.
- 9 Release the control handle.
- ⦿ Result: The platform should stop raising.
- 10 Press and hold the function enable switch. Slowly move the control handle in the direction indicated by the yellow arrow.
- ⦿ Result: The platform should lower. The descent alarm should sound while the platform is lowering.

**NOTICE** **CE models:** When lowering the platform, the platform should stop when it is 7 feet (2.1 m) from the ground. Be sure the area below the platform is clear of personnel and obstructions before continuing. To continue lowering, release the control handle, wait 5 seconds, then move the control handle again.

**NOTICE** As a safety feature, selecting and operating the ground controls will override the platform controls, except the platform Emergency Stop button.

## A-7 Test the Manual Platform Lowering Operation

Detection of Manual Platform Lowering system malfunctions is essential for safe machine operation. An unsafe working condition exists if the Manual Platform Lowering function does not operate in the event of a main power loss.

- 1 Turn the key switch to ground control and pull out the Emergency Stop button to the ON position at both the platform and ground controls.
- 2 Raise the platform approximately 2 feet (0.6 m).
- 3 Pull the Manual Platform Lowering handle located next to the ground controls.
- ⦿ Result: The platform should lower. The descent alarm will not sound.

TABLE A PROCEDURES

## A-8 Test the Tilt Sensor

**NOTICE** Perform this test from the ground with the platform controls. Do not stand in the platform.

- 1 Fully lower the platform.
- 2 Place a 2x4 block or similar piece of wood under both wheels on one side and drive the machine up onto them.
- 3 Raise the platform.
- ⦿ Result: When the platform is raised 7 feet (2.1 meters) from the ground, an alarm should sound.
- 4 Lower the platform and remove both pieces of wood.

## A-9 Test the Pothole Guards

**NOTICE** The pothole guards should automatically deploy when the platform is raised. The pothole guards activate two limit switches which control the machine drive speed. If the pothole guards do not deploy and the platform is raised above 6 feet (1.8 meters), an alarm sounds and the machine will not drive.

- 1 Raise the platform.
- ⦿ Result: When the platform is raised 4 feet (1.2 meters) from the ground, the pothole guards should deploy.
- 2 Press on the pothole guards on one side, and then the other.
- ⦿ Result: The pothole guards should not move.
- 3 Lower the platform.
- ⦿ Result: The pothole guards should return to the stowed position.
- 4 Place a 2x4 block or similar piece of wood under the pothole guard. Raise the platform.
- ⦿ Result: When the platform is raised approximately 7 to 8 feet (2.1 to 2.4 meters), an alarm should sound and the drive function should not work.
- 5 Lower the platform and remove the 2x4 block.

TABLE A PROCEDURES

### A-10 Test the Lift/Drive Select Switch (before serial number 17408)

A properly functioning Lift/Drive Select Switch is essential for safe machine operation. An improperly operating Lift/Drive Select Switch will fail to activate the appropriate platform control which may result in a hazardous situation.

- 1 Turn the key switch to platform control and pull out the Emergency Stop button to the ON position at both the platform and ground controls.
- 2 Move the lift/drive select switch to the LIFT position.
- 3 Press and hold the function enable switch.
  - ⦿ Result: The green power light should come on.
- 4 Slowly move the control handle off center.
  - ⦿ Result: The platform should raise or lower.
- 5 Move the lift/drive select switch to the DRIVE position.
- 6 Press and hold the function enable switch.
  - ⦿ Result: The green power light should come on.
- 7 Slowly move the control handle off center.
  - ⦿ Result: The drive and steer functions should operate.

### A-11 Perform 30 Day Service

The 30 day maintenance procedure is a onetime sequence of procedures to be performed after the first 30 days or 50 hours of usage. After this interval, refer to the maintenance tables for continued scheduled maintenance.

- 1 Perform the following maintenance procedures:
  - B-3 Inspect Tires and Wheels
  - C-1 Replace the Hydraulic Filter

## Table B Procedures

### B-1 Check the Batteries

Proper battery condition is essential to good machine performance and operational safety. Improper fluid levels or damaged cables and connections can result in component damage and hazardous conditions.

**AWARNING** Bodily injury hazard. Batteries contain acid. Avoid spilling or contacting battery acid. Neutralize battery acid spills with baking soda and water.

**AWARNING** Electrocutation hazard. Contact with hot or live circuits may result in death or serious injury. Remove all rings, watches and other jewelry.

**NOTICE** Perform this test after fully charging the batteries.

- 1 Put on protective clothing and eye wear.
- 2 Be sure that the battery cable connections are free of corrosion.
- 3 Be sure that the battery hold downs and cable connections are tight.
- 4 Remove the battery vent caps and check the specific gravity of each battery cell with a hydrometer.
- ⦿ Result: If any battery cell displays a specific gravity of less than 1.098, the battery must be replaced.
- 5 Check the battery acid level of each battery. If needed, replenish with distilled water to the bottom of the battery fill tube. Do not overfill.
- 6 Install the battery vent caps.

- 7 Check each battery pack and verify that the batteries are wired correctly.

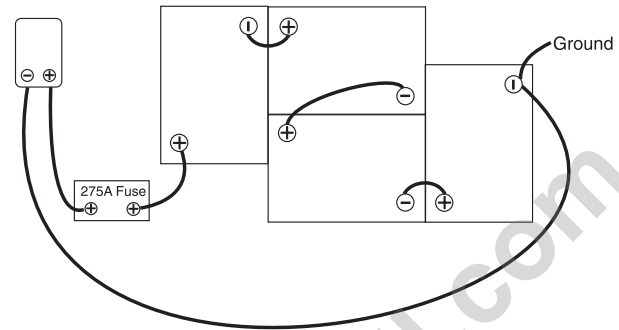

## TABLE B PROCEDURES

## B-2 Inspect the Electrical Wiring

Maintaining electrical wiring in good condition is essential to safe operation and good machine performance. Failure to find and replace burnt, chafed, corroded or pinched wires could result in unsafe operating conditions and may cause component damage.

**AWARNING** Electrocutation hazard. Contact with hot or live circuits may result in death or serious injury. Remove all rings, watches and other jewelry.

- 1 Inspect the following areas for burnt, chafed, corroded and loose wires:
  - Ground control panel
  - Hydraulic power unit module tray
  - Battery pack module tray
  - Scissor arms
  - Platform controls
- 2 Turn the key switch to ground control and pull out the Emergency Stop button to the ON position.
- 3 Raise the platform approximately 8 feet (2.4 m) from the ground.
- 4 Rotate the safety arm away from the machine and let it hang down.
- 5 Lower the platform onto the safety arm.

**AWARNING** Crushing hazard. Keep hands clear of the safety arm when lowering the platform.

- 6 Inspect the center chassis area and scissor arms for burnt, chafed and pinched cables.
- 7 Inspect the following areas for burnt, chafed, corroded, pinched and loose wires:
  - ECM to platform controls
  - Power to platform wiring
- 8 Raise the platform and return the safety arm to the stowed position.
- 9 Lower the platform to the stowed position and turn the machine off.

TABLE B PROCEDURES

### B-3 Inspect the Tires and Wheels (including castle nut torque)

Maintaining the tires and wheels in good condition is essential to safe operation and good performance. Tire and/or wheel failure could result in a machine tip-over. Component damage may also result if problems are not discovered and repaired in a timely fashion.

- 1 Check the tire surface and sidewalls for cuts, cracks, punctures and unusual wear.
- 2 Check each wheel for damage, bends and cracks.
- 3 Remove the cotter pin and check each castle nut for proper torque.
- 4 Install a new cotter pin.

**NOTICE** Always replace the cotter pin with a new one when removing the castle nut or when checking the torque of the castle nut.

#### Tires and wheels

Castle nut torque, dry	300 ft-lbs	406.7 Nm
Castle nut torque, lubricated	225 ft-lbs	305 Nm

### B-4 Test the Key Switch

Proper key switch action and response is essential to safe machine operation. The machine can be operated from the ground or platform controls and the activation of one or the other is accomplished with the key switch. Failure of the key switch to activate the appropriate control panel could cause a hazardous operating situation.

- 1 Pull out the Emergency Stop button to the ON position at both the ground and platform controls.
- 2 Turn the key switch to **platform control**.
- 3 Check the platform up/down function from the **ground controls**.
  - ⊙ Result: The machine functions should **not** operate.
- 4 Turn the key switch to **ground control**.
- 5 Check the machine functions from the **platform controls**.
  - ⊙ Result: The machine functions should **not** operate.
- 6 Turn the key switch to the OFF position.
  - ⊙ Result: No function should operate.

TABLE B PROCEDURES

## B-5 Test the Emergency Stop Buttons

Properly functioning Emergency Stop buttons are essential for safe machine operation. An improperly operating Emergency Stop button will fail to shut off power and stop all machine functions resulting in a hazardous situation.

**NOTICE** As a safety feature, selecting and operating the ground controls will override the platform controls, except the platform Emergency Stop button.

- 1 Turn the key switch to ground control and pull out the Emergency Stop button to the ON position at both the ground and platform controls.
  - 2 Push in the Emergency Stop button at the ground controls to the OFF position.
- ⊙ Result: No functions should operate.
- 3 Turn the key switch to platform control and pull out the Emergency Stop button to the ON position at both the ground and platform controls.
  - 4 Push down the Emergency Stop button at the platform controls to the OFF position.
- ⊙ Result: No machine functions should operate.

**NOTICE** The ground control Emergency Stop button will stop all machine operation, even if the key switch is switched to platform control.

## B-6 Test the Horn

A functioning horn is essential to safe machine operation. The horn is activated at the platform controls and sounds at the ground as a warning to ground personnel. An improperly functioning horn will prevent the operator from alerting ground personnel of hazards or unsafe conditions.

- 1 Turn the key switch to platform control and pull out the Emergency Stop button to the ON position at both the ground and platform controls.
  - 2 Push down the horn button at the platform controls.
- ⊙ Result: The horn should sound.

TABLE B PROCEDURES

## B-7 Test the Drive Brakes

Proper brake action is essential to safe machine operation. The drive brake function should operate smoothly, free of hesitation, jerking and unusual noise. Hydraulically-released individual wheel brakes can appear to operate normally when not fully operational.

**NOTICE** Perform this procedure with the machine on a firm, level surface that is free of obstructions.

**NOTICE** Be sure the platform extension deck is fully retracted and the platform is in the stowed position.

- 1 Mark a test line on the ground for reference.
- 2 Turn the key switch to platform control and pull out the Emergency Stop button to the ON position at both the ground and platform controls.
- 3 Lower the platform to the stowed position.
- 4 Move the lift/drive selector switch to the drive position (if equipped).
- 5 Choose a point on the machine; i.e., contact patch of a tire, as a visual reference for use when crossing the test line.
- 6 Bring the machine to full drive speed before reaching the test line. Release the function enable switch or the joystick on the platform controls when your reference point on the machine crosses the test line.

- 7 Measure the distance between the test line and your machine reference point.

---

### Braking: paved surface

---

Stopping distance	2 ft	0.6 m
-------------------	------	-------

---

- ⊙ Result: The machine stops within the specified braking distance. No action required.
- ⊗ Result: The machine does not stop within the specified braking distance. Proceed to step 8 and determine if the machine is equipped with a dynamic braking valve.

**NOTICE** The brakes must be able to hold the machine on any slope it is able to climb.

- 8 Disconnect the battery pack from the machine.

**⚠ WARNING** Electrocution hazard. Contact with electrically charged circuits could result in death or serious injury. Remove all rings, watches and other jewelry.

- 9 Locate the drive forward/reverse valve on the function manifold. Refer to Illustrations 1.

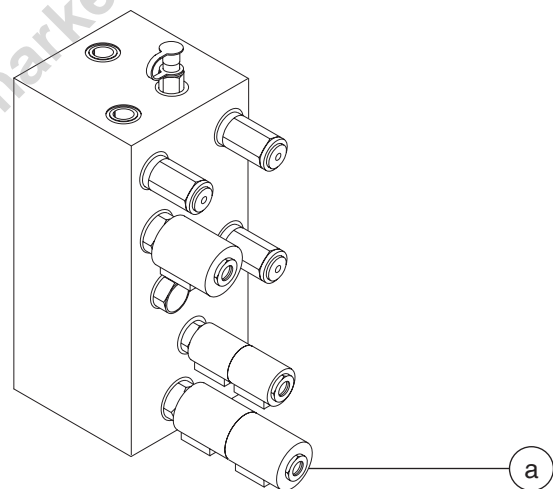

a drive forward/reverse valve

## TABLE B PROCEDURES

- 10 Tag the forward and the reverse valve coils.  
Remove the coils from the valve.

**NOTICE** The forward valve coil has white and brown wires attached.

**NOTICE** The reverse valve coil has white/black and brown wires attached.

**NOTICE** For reassembly, it will be helpful to leave the wire harness attached to the valve coils.

- 11 Remove the drive forward/reverse valve from the function manifold. Cap the open port of the manifold.
- 12 Carefully inspect the hex portion of the valve for an identification stamp.
- ⦿ Result: SV10-4727 is stamped on the hex portion of the drive forward/reverse valve. This indicates the machine is equipped with a dynamic brake valve. Proceed to step 13.
  - ⊗ Result: SV10-4727 is not stamped on the hex portion of the drive forward/reverse valve. This indicates the machine is not equipped with a dynamic brake valve. Proceed to step 18.
- 13 Install the drive forward/reverse valve removed in step 11 into the function manifold and securely tighten. Torque to 25 ft-lbs / 34 Nm.
- 14 In order, install the reverse valve coil (with white/black and brown wires), spacer washer and the forward valve coil (with white and brown wires) onto the valve.

**NOTICE** For the machine to function correctly, the reverse valve coil must be closest to the manifold.

- 15 Install the coil nut onto the valve and tighten.  
Torque to 60 in-lbs / 7 Nm.

- 16 Connect the battery pack to the machine.

- 7 Replace the brakes and repeat this procedure beginning with step 1. Refer to Repair Procedure 8-1, *How to Remove a Drive Brake*.

- 18 Contact the Genie Industries Service Parts Department and order kit part number 105457.

- 19 Install the new valve received in the kit and mark the new valve with a white paint pen to identify new valve installation.

- 20 Repeat this procedure beginning with step 1.

**If the machine fails to stop within the specified stopping distance after installing new brakes, please contact the Genie Industries Scissors Service Department, 1-800-536-1800 Ext. 8710.**

TABLE B PROCEDURES

**B-8****Test the Drive Speed -  
Stowed Position**

Proper drive functions are essential to safe machine operation. The drive function should respond quickly and smoothly to operator control. Drive performance should also be free of hesitation, jerking and unusual noise over the entire proportionally controlled speed range.

**NOTICE** Select a test area that is firm, level and free of obstructions.

- 1 Create start and finish lines by marking two lines on the ground 40 feet (12.2 m) apart.
- 2 Turn the key switch to platform control and pull out the Emergency Stop button to the ON position at both the ground and platform controls.
- 3 Lower the platform to the stowed position.
- 4 Choose a point on the machine; i.e., contact patch of a tire, as a visual reference for use when crossing the start and finish lines.
- 5 Bring the machine to maximum drive speed before reaching the start line. Begin timing when your reference point on the machine crosses the start line.
- 6 Continue at full speed and note the time when the machine reference point passes over the finish line. Return the control handle to center.

**Drive speed:**

Stowed position	40 ft / 10.1 sec	12.2 m / 10.1 sec
-----------------	------------------	-------------------

**B-9****Test the Drive Speed -  
Raised Position**

Proper drive functions are essential to safe machine operation. The drive function should respond quickly and smoothly to operator control. Drive performance should also be free of hesitation, jerking and unusual noise over the entire proportionally controlled speed range.

**NOTICE** Select a test area that is firm, level and free of obstructions.

- 1 Create start and finish lines by marking two lines on the ground 40 feet (12.2 m) apart.
- 2 Turn the key switch to platform control and pull out the Emergency Stop button to the ON position at both the ground and platform controls.
- 3 Raise the platform approximately 6 feet (2 m).
- 4 Choose a point on the machine; i.e., contact patch of a tire, as a visual reference for use when crossing the start and finish lines.
- 5 Bring the machine to maximum drive speed before reaching the start line. Begin timing when your reference point on the machine crosses the start line.
- 6 Continue at full speed and note the time when the machine reference point passes over the finish line. Return the control handle to center.

**Drive speed (maximum):**

Platform raised	40 ft / 55 sec	12.2 m / 55 sec
-----------------	----------------	-----------------

## TABLE B PROCEDURES

**B-10**  
**Perform Hydraulic Oil Analysis**

See D-1, *Test or Replace the Hydraulic Oil.*

**B-11**  
**Check the Electrical Contactor -  
(before serial number 6901)**

Maintaining the electrical contactor in good condition is essential to safe machine operation. Failure to locate a worn or damaged contactor could result in an unsafe working condition and component damage.

- 1 Open the hydraulic power unit module and locate the electrical contactor mounted above the hydraulic power unit.
- 2 Visually inspect the contact points of each contactor for the following items:
  - Excessive burns
  - Excessive arcs
  - Excessive pitting

**NOTICE**

Replace the contactor if any damage is found.

# Table C Procedure

## C-1

### Replace the Hydraulic Filter

Replacement of the hydraulic filter is essential for good machine performance and service life. A dirty or clogged filter may cause the machine to perform poorly and continued use may cause component damage. Extremely dirty conditions may require that the filter be replaced more often.

**CAUTION** Beware of hot oil. Contact with hot oil may cause severe burns.

**NOTICE** The hydraulic filter is mounted on the function manifold next to the hydraulic power unit.

- 1 Clean the area around the oil filter, then remove the filter with an oil filter wrench.
- 2 Apply a thin layer of oil to the new oil filter gasket.
- 3 Install the new filter (Genie part number 44788) and tighten it securely by hand. Clean up any oil that may have spilled during the replacement procedure.
- 4 Turn the key switch to ground control and pull out the Emergency Stop button to the ON position at both the ground and platform controls. Activate and hold the platform up toggle switch.
- 5 Inspect the filter and related components to be sure that there are no leaks.

# Table D Procedure

## D-1 Test or Replace the Hydraulic Oil

Replacement or testing of the hydraulic oil is essential for good machine performance and service life. Dirty oil and suction strainer may cause the machine to perform poorly and continued use may cause component damage. Extremely dirty conditions may require oil changes to be performed more often.

**NOTICE** This machine uses Dexron equivalent hydraulic oil. Before replacing the hydraulic oil, the oil may be tested by an oil distributor for specific levels of contamination to verify that changing the oil is necessary. **If the hydraulic oil is not replaced at the two year inspection, test the oil quarterly. Replace the oil when it fails the test.**

**NOTICE** Perform this procedure with the platform in the stowed position.

- 1 Disconnect the battery pack from the machine.
- 2 Open the power unit compartment and place a drain pan or other suitable container under the hydraulic tank.
- 3 Remove the drain plug from the hydraulic tank.

**WARNING** Bodily injury hazard. Spraying hydraulic oil can penetrate and burn skin. Loosen hydraulic connections very slowly to allow the oil pressure to dissipate gradually. Do not allow oil to squirt or spray.

- 4 Completely drain the tank into a suitable container. See capacity specifications listed above.
- 5 Remove the return filter mounting bracket fasteners from the manifold. Push the filter and accumulator out of the way.

- 6 Remove the motor controller mounting bracket retaining fasteners and move the motor controller to the side.
- 7 Remove the hydraulic tank from the machine.
- 8 Remove the suction strainer and clean it using a mild solvent.
- 9 Clean the inside of the hydraulic tank using a mild solvent.
- 10 Install the suction strainer using thread sealer on the threads.
- 11 Install the drain plug using thread sealer on the threads.
- 12 Install the hydraulic filter bracket and the Curtis motor controller bracket.

**WARNING** Electrocutation hazard. The connectors on the motor controller will short out to ground if the motor controller mounting bracket is not installed before the battery pack is connected.

- 13 Install the hydraulic tank.
- 14 Fill the tank with hydraulic oil until the fluid is within the FULL and ADD marks on the oil level indicator decal. Do not overfill.
- 15 Clean up any oil that may have spilled. Properly discard of oil.

---

### Hydraulic oil type - Dexron equivalent

---

Hydraulic tank capacity	5 gallons 18.9 liters
Hydraulic system (including tank)	5.5 gallons 20.8 liters

---



This page intentionally left blank.

Provided for Free by Trenchwell.com  
Shop Aftermarket Parts

# Troubleshooting Flow Charts



## Observe and Obey:

- ☑ Troubleshooting and repair procedures shall be completed by a person trained and qualified on the repair of this machine.
- ☑ Immediately tag and remove from service a damaged or malfunctioning machine.
- ☑ Repair any machine damage or malfunction before operating the machine.
- ☑ Unless otherwise specified, perform each repair procedure with the machine in the following configuration:
  - Machine parked on a flat level surface
  - Platform in stowed position
  - Key switch in the OFF position with the key removed
  - Wheels chocked

## Before Troubleshooting:

- ☑ Read, understand and obey the safety rules and operating instructions printed in the *Genie GS-1530 & Genie GS-1930 Operator's Manual*.
- ☑ Be sure that all necessary tools and test equipment are available and ready for use.
- ☑ Read each appropriate flow chart thoroughly. Attempting shortcuts may produce hazardous conditions.
- ☑ Be aware of the following hazards and follow generally accepted safe workshop practices.

**⚠ DANGER** Crushing hazard. When testing or replacing any hydraulic component, always support the structure and secure it from movement.

**⚠ DANGER** Electrocutation hazard. Contact with electrically charged circuits may result in death or serious injury. Remove all rings, watches and other jewelry.

**⚠ WARNING** Bodily injury hazard. Spraying hydraulic oil can penetrate and burn skin. Loosen hydraulic connections very slowly to allow the oil pressure to dissipate gradually. Do not allow oil to squirt or spray.

**NOTICE** Perform all troubleshooting on a firm level surface.

**NOTICE** Two persons will be required to safely perform some troubleshooting procedures.

## TROUBLESHOOTING FLOW CHARTS

**About This Section**

When a malfunction is discovered, the flow charts in this section will help a service professional pinpoint the cause of the problem. To use this section, basic hand tools and certain pieces of test equipment are required—voltmeter, ohmmeter, pressure gauges.

The location of terminals mentioned in this section can be found on the appropriate electrical or hydraulic schematics provided in Section 6, *Schematics*.

Since various degrees of a particular function loss may occur, selecting the appropriate flow chart may be troublesome. When a function will not operate with the same speed or power as a machine in good working condition, refer to the flow chart which most closely describes the problem.

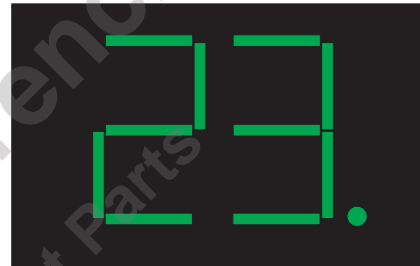
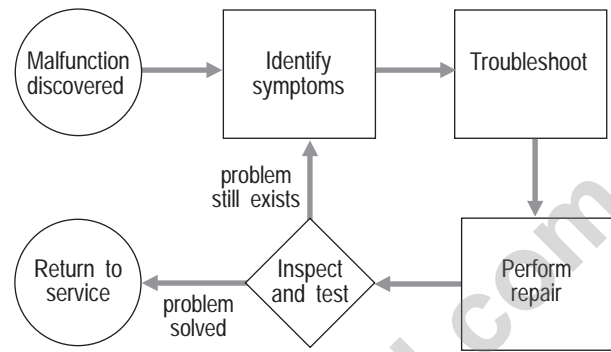
**General Repair Process****LED Diagnostic Readout**

The diagnostic readout displays numerical codes that provide information about the machine operating status and about malfunctions. The dot to the right of the numbers will blink during normal operation codes and remain on with fault codes.

The codes listed in the Operation Code Chart are common operational status codes and malfunction codes that can be cleared easily.

The codes listed in the Fault Code Chart describe malfunctions and can aid in troubleshooting the machine by pinpointing the area or component affected.

# Fault Code Chart

## (Before Serial Number 17408)

Fault Code	Problem	Possible Causes	Solution
00			Reset the ECM. If problem remains, replace the ECM.
18	Alarm sounds continuously. Error indicator light on at the platform controls when function enable switch is engaged. Machine will not drive. Machine is not level.	Pothole guard may be blocked or pothole limit switches may not be activating or there is a bad wire connection.	Remove obstruction to pothole guard OR check pothole limit switch wiring for open connections OR check pothole limit switch for proper adjustment and activation.
19	Alarm sounds continuously. Error indicator light on at the platform controls when function enable switch is engaged. Machine will not drive. Machine is level.	Pothole guard may be blocked or pothole limit switches may not be activating or there is a bad wire connection.	Remove obstruction to pothole guard OR check pothole limit switch wiring for open connections OR check pothole limit switch for proper adjustment and activation.
33	Machine will not operate. Error indicator light on at the platform controls.	Joystick initialization OK but function enable switch is tied down.	Release the function enable switch OR check the switch for continuity in the joystick controller box (see Repair Section).
34	Machine unit will not operate. Error indicator light on at the platform controls.	ECM does not recognize the platform controls.	Replace joystick controller box main circuit board OR replace the coil cord.
35	Machine unit will not operate. Error indicator light on at the platform controls.	ECM does not recognize the platform controls.	Replace joystick controller box main circuit board.
51	Only the platform down function operates no other functions operate. Error indicator light on at the platform controls when the function enable switch is engaged.	No power output from ECM to the motor contactor.	Check wiring and terminal at motor contactor ckt A9-Curtis terminal 3 OR check wiring and terminal at control ECM pin A9, ckt A9-Curtis terminal 3.

## Notes

---



---



---



---



---



Continued on next page

**FAULT CODE CHART**  
(BEFORE SERIAL NUMBER 17408)

<b>Fault Code</b>	<b>Problem</b>	<b>Possible Causes</b>	<b>Solution</b>
52	Machine will not drive forward. Pump motor starts. Error indicator light on at the platform controls when the function enable switch is engaged.	No power output from ECM to the drive forward coil.	Check wiring and terminal at the forward coil, ckt C6-Forward coil OR check wiring and terminal at control ECM pin C6, ckt C6 Forward coil.
53	Machine will not drive in reverse. Pump motor starts. Error indicator light on at the platform controls when the function enable switch is engaged.	No power output from ECM to the drive reverse coil.	Check wiring and terminal at the reverse coil, ckt A7-Reverse coil OR check wiring and terminal at ECM pin A7, ckt A7 Reverse coil.
54	Platform will not raise. Pump motor starts. Error indicator light on at the platform controls when the function enable switch is engaged.	No power output from ECM to the platform up coil.	Check wiring and terminal at the platform up coil, ckt A6-Up coil OR check wiring and terminal at ECM pin A6, ckt A6 Up coil.
55	Platform will not lower. Error indicator light on at the platform controls when the function enable switch is engaged.	No power output from ECM to the platform lowering coil.	Check wiring and terminal at the platform lowering coil, ckt B6-Down coil OR check wiring and terminal at ECM pin B6, ckt B6 Down coil.
56	Machine will not steer right. Pump motor starts. Error indicator light on at the platform controls when the function enable switch is engaged.	No power output from ECM to steer right coil.	Check wiring and terminal at the steer right coil, ckt C7 Right coil OR check wiring and terminal at ECM pin C7, C7 Right coil.
57	Machine will not steer left. Pump motor starts. Error indicator light on at the platform controls when the function enable switch is engaged.	No power output from ECM to steer left coil.	Check wiring and terminal at the steer left coil, ckt B7 Left coil OR check wiring and terminal at ECM pin B7, B7 Left coil.
58	Machine will not drive but platform will still raise.	No power output from ECM to the brake orifice coil.	Check wiring and terminal at the orifice coil, ckt C9 orifice coil OR check wiring and terminal at ECM pin C9, C9 orifice coil OR replace Coil.

## Notes



Continued on next page



# Normal Operation Code Chart

## (Before Serial Number 17408)

Code	Condition	Explanation
20 flashing	Key switch to platform control. Platform extended above 6 feet. Ground control and platform Emergency Stop buttons pulled out to the on position.	Machine was operating normally, then the platform Emergency Stop button was pushed in and the key switch was turned to ground control. Alarm will go off until key switch is turned to platform control or the platform Emergency Stop button is pulled out.
21 flashing	Key switch to platform control. Platform extended above 6 feet. Ground control and platform Emergency Stop buttons pulled out to the on position.	Normal operation.
22 flashing	Key switch to ground control. Ground control Emergency Stop button pulled out to the on position. Platform control Emergency Stop button pushed in to the off position.	To clear this code, be sure joystick is properly connected or pull the platform Emergency Stop button out to the on position.
23 flashing	Key switch to ground control. Ground control and platform Emergency Stop buttons pulled out to the on position. Error indicator light at platform controls is on.	Turn key switch to platform control.
24 flashing	Key switch to ground control. Ground control Emergency Stop button pulled out to the on position. Platform control Emergency Stop button pushed in to the off position. Platform extended less than 6 feet.	To clear this code, be sure joystick is properly connected or pull the platform Emergency Stop button out to the on position.
25 flashing	Key switch to ground control. Ground control and platform Emergency Stop buttons pulled out to the on position. Error indicator light at platform controls is on. Platform extended less than 6 feet.	Turn key switch to platform control.
31 flashing	Key switch to platform control. Ground control and platform Emergency Stop buttons pulled out to the on position.	Normal operation.
32 flashing	Key switch to platform control. Ground control Emergency Stop button pulled out to the on position. Platform control Emergency Stop button pushed in to the off position.	To clear this code, be sure joystick is properly connected or pull the platform Emergency Stop button out to the on position.
36 flashing	Key switch to platform control. Ground control and platform Emergency Stop buttons pulled out to the on position. Lift/drive switch to lift position.	Up function selected. Note: if joystick controller is returned to center position before function enable button is released, code 31 flashing will appear. If function enable button is released first, code 36 flashing will remain until another function is selected.
37 flashing	Key switch to platform control. Ground control and platform Emergency Stop buttons pulled out to the on position. Lift/drive switch to lift position.	Down function selected. Note: if joystick controller is returned to center position before function enable button is released, code 31 flashing will appear. If function enable button is released first, code 37 flashing will remain until another function is selected.
38 flashing	Key switch to platform control. Ground control and platform Emergency Stop buttons pulled out to the on position. Lift/drive switch to drive position.	Drive in blue direction function selected. Note: if joystick controller is returned to center position before function enable button is released, code 31 flashing will appear. If function enable button is released first, code 38 flashing will remain until another function is selected.
39 flashing	Key switch to platform control. Ground control and platform Emergency Stop buttons pulled out to the on position. Lift/drive switch to drive position.	Drive in yellow direction function selected. Note: if joystick controller is returned to center position before function enable button is released, code 31 flashing will appear. If function enable button is released first, code 39 flashing will remain until another function is selected.
40 flashing	Key switch to platform control. Ground control and platform Emergency Stop buttons pulled out to the on position. Function enable switch pressed.	Horn is being pressed. Note: Horn will operate without code 40 flashing if function enable switch is not pressed in.

Provided for Free by Trenchwell.com  
Shop Aftermarket Parts

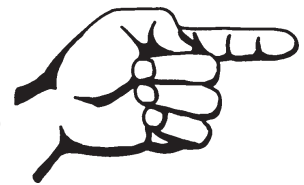

This page intentionally left blank.

# Fault Code Chart

## (After Serial Number 17407)

Fault Code	Problem	Possible Causes	Solution
01	Machine will not operate. ECM cannot be reset.	EPROM not programmed.	Replace ECM.
02	Platform ECM error.	EPROM not programmed.	Replace ECM.
03	Undefined platform DIP switch settings.	DIP switch settings incorrect.	Correct DIP switch settings.
12	Chassis up/down switch closed at start up.	Malfunctioning up/down switch.	Troubleshoot up/down switch.
18	Pothole guard failure.	Malfunctioning pothole switch OR obstruction in pothole guard linkage.	Troubleshoot pothole switch OR remove obstruction.
42	Platform left turn switch closed at start up.	Malfunctioning steer left microswitch.	Troubleshoot steer left microswitch.
43	Platform right turn switch closed at start up.	Malfunctioning steer right microswitch.	Troubleshoot steer right microswitch.
45	Platform lift enable switch closed at start up.	Malfunctioning lift enable switch.	Troubleshoot lift enable switch.
46	Platform drive enable switch closed at start up.	Malfunctioning drive enable switch.	Troubleshoot drive enable switch.
47	Platform joystick off neutral at start up.	Joystick potentiometer not centered.	Verify potentiometer setting.
52	Forward coil error.	Malfunctioning coil OR wire disconnected from coil.	Troubleshoot coil OR inspect wire connection.
53	Reverse coil error.	Malfunctioning coil OR wire disconnected from coil.	Troubleshoot coil OR inspect wire connection.
54	Up coil error.	Malfunctioning coil OR wire disconnected from coil.	Troubleshoot coil OR inspect wire connection.
55	Down coil error.	Malfunctioning coil OR wire disconnected from coil.	Troubleshoot coil OR inspect wire connection.
56	Right coil error.	Malfunctioning coil OR wire disconnected from coil.	Troubleshoot coil OR inspect wire connection.
57	Left coil error.	Malfunctioning coil OR wire disconnected from coil.	Troubleshoot coil OR inspect wire connection.
58	Brake coil error.	Malfunctioning coil OR wire disconnected from coil.	Troubleshoot coil OR inspect wire connection.
68	Low Voltage.	Batteries discharged.	Charge batteries.

## Notes

---



---



---

# Chart 1

## All Functions Will Not Operate

Be sure the circuit breaker and fuse are not tripped or blown.

Be sure the batteries are properly connected.

Be sure the batteries are fully charged.

Be sure both Emergency Stop switches are pulled out to the ON position.

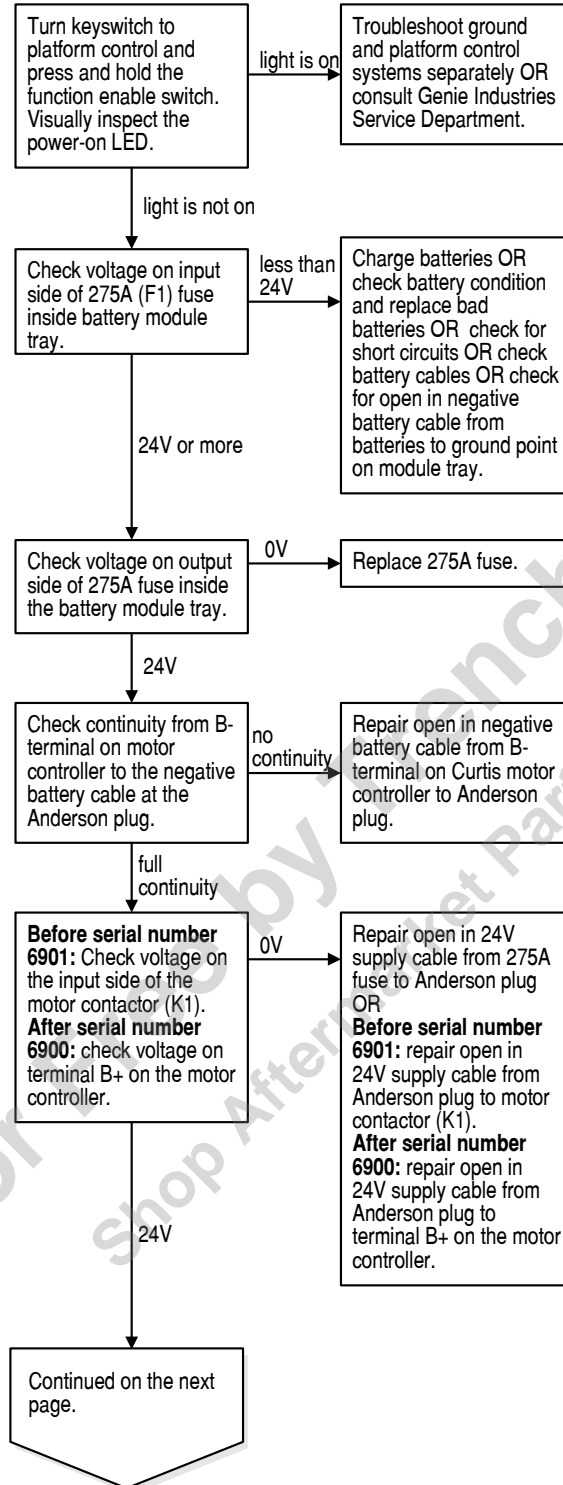

CHART 1

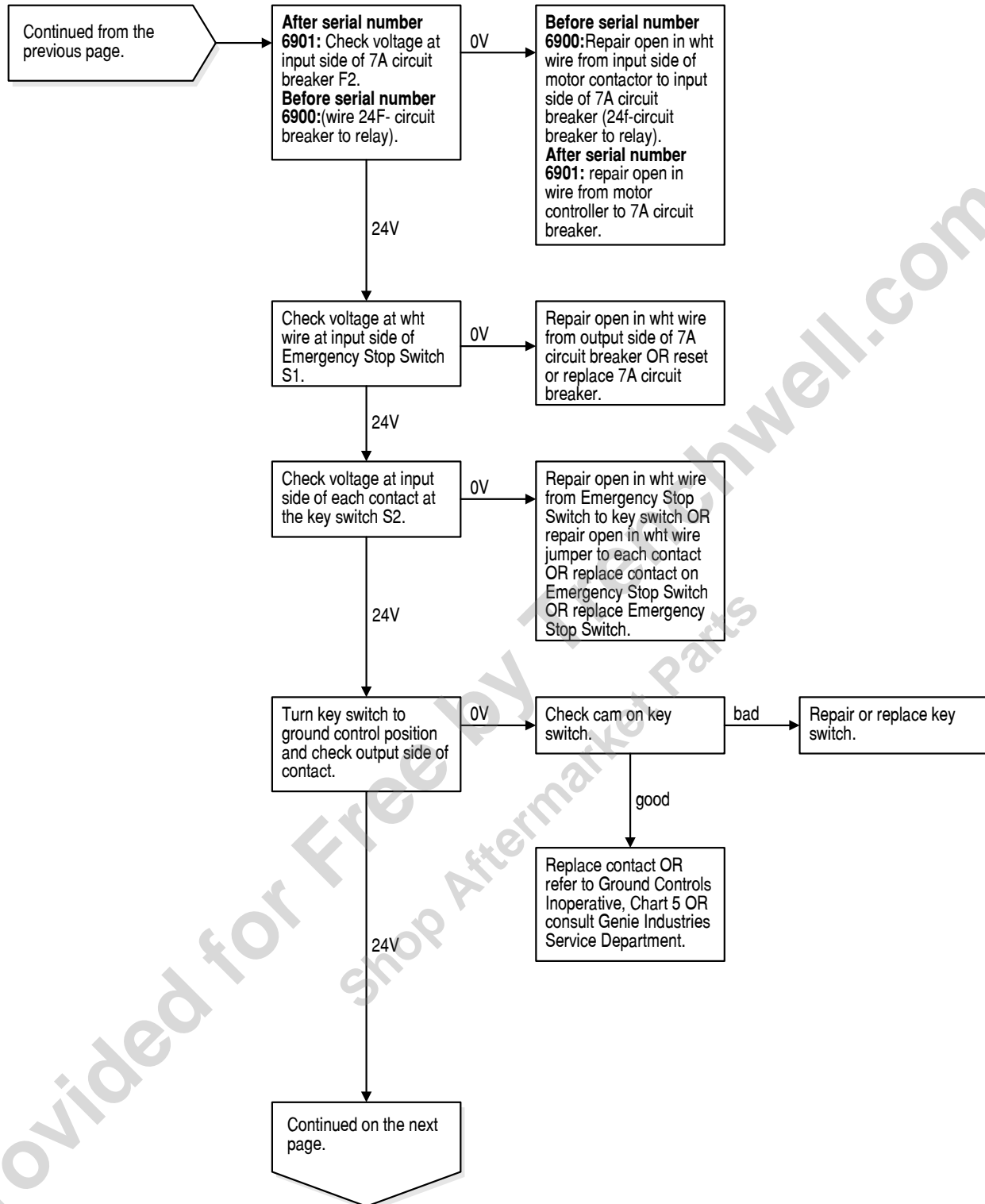
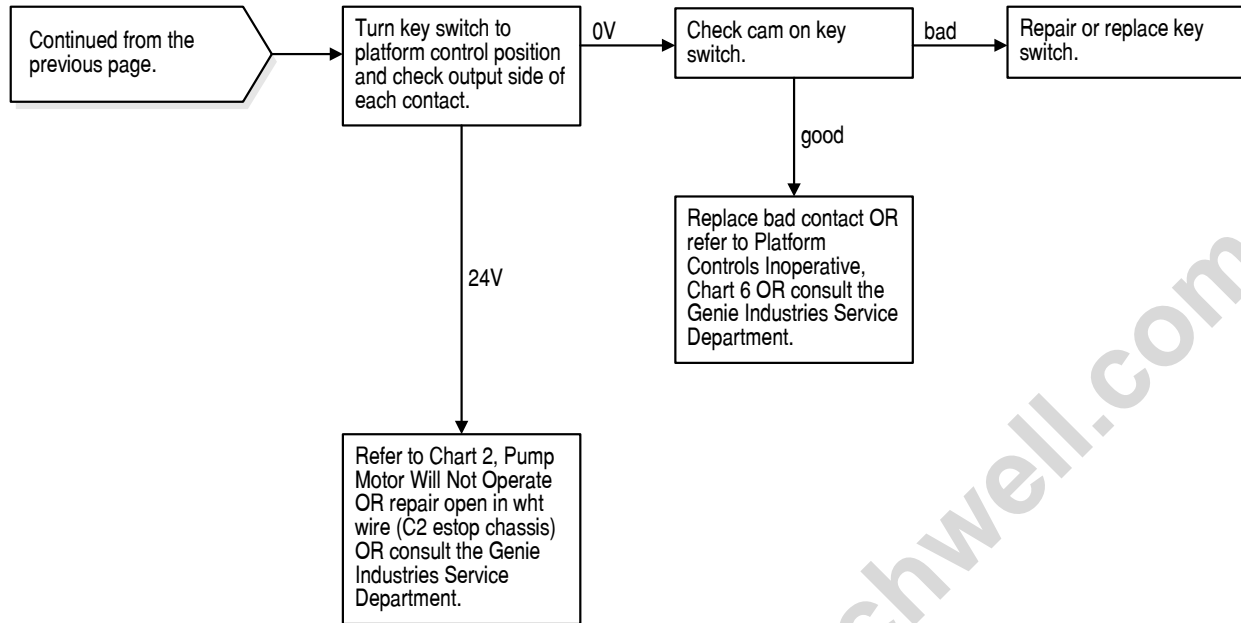

CHART 1



Provided for Free by Trenchwell.com  
 Shop Aftermarket Parts

# Chart 2

## Pump Motor Will Not Operate

Be sure the circuit breaker and fuse are not tripped or blown.

Be sure the batteries are properly connected.

Be sure the batteries are fully charged.

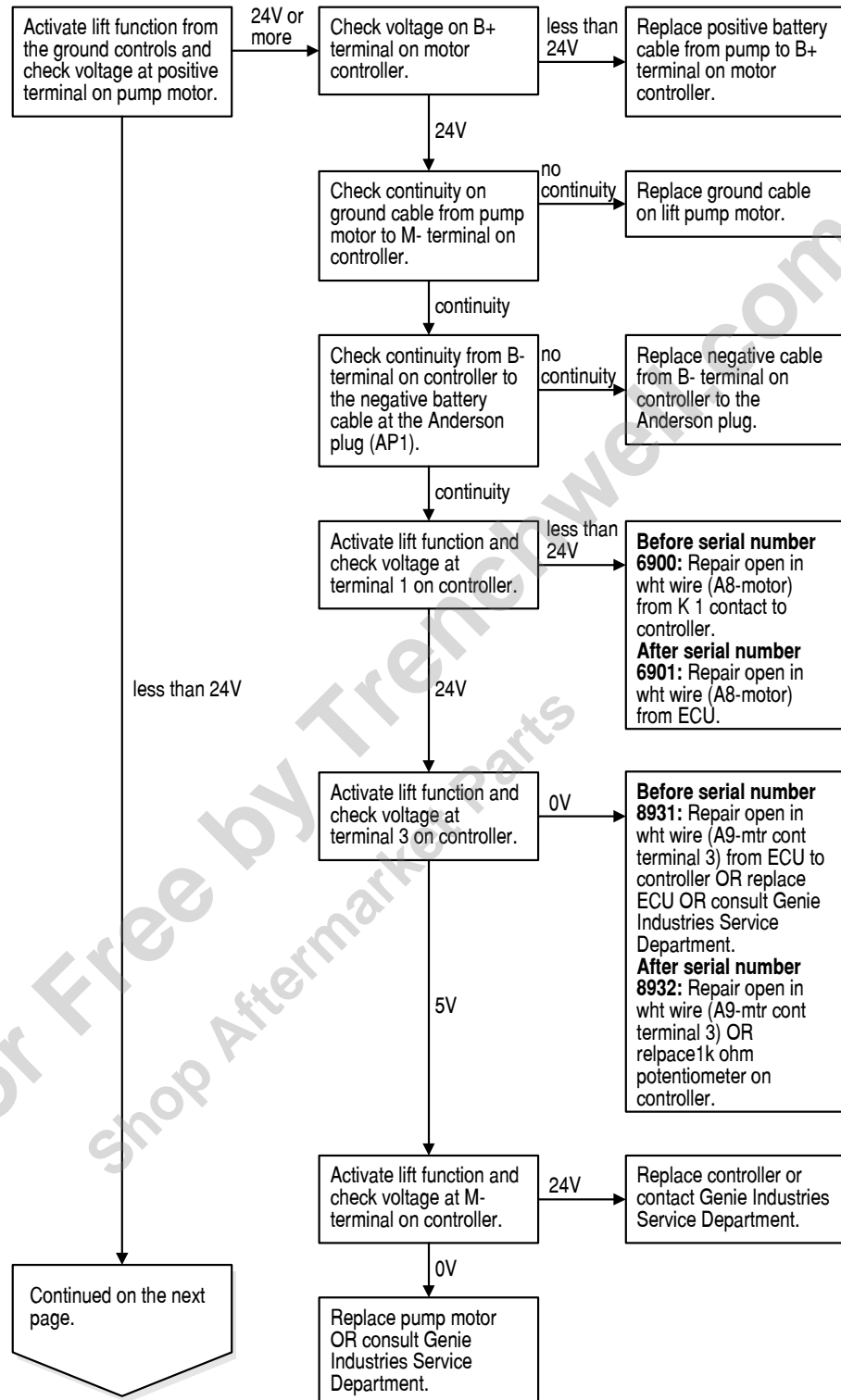
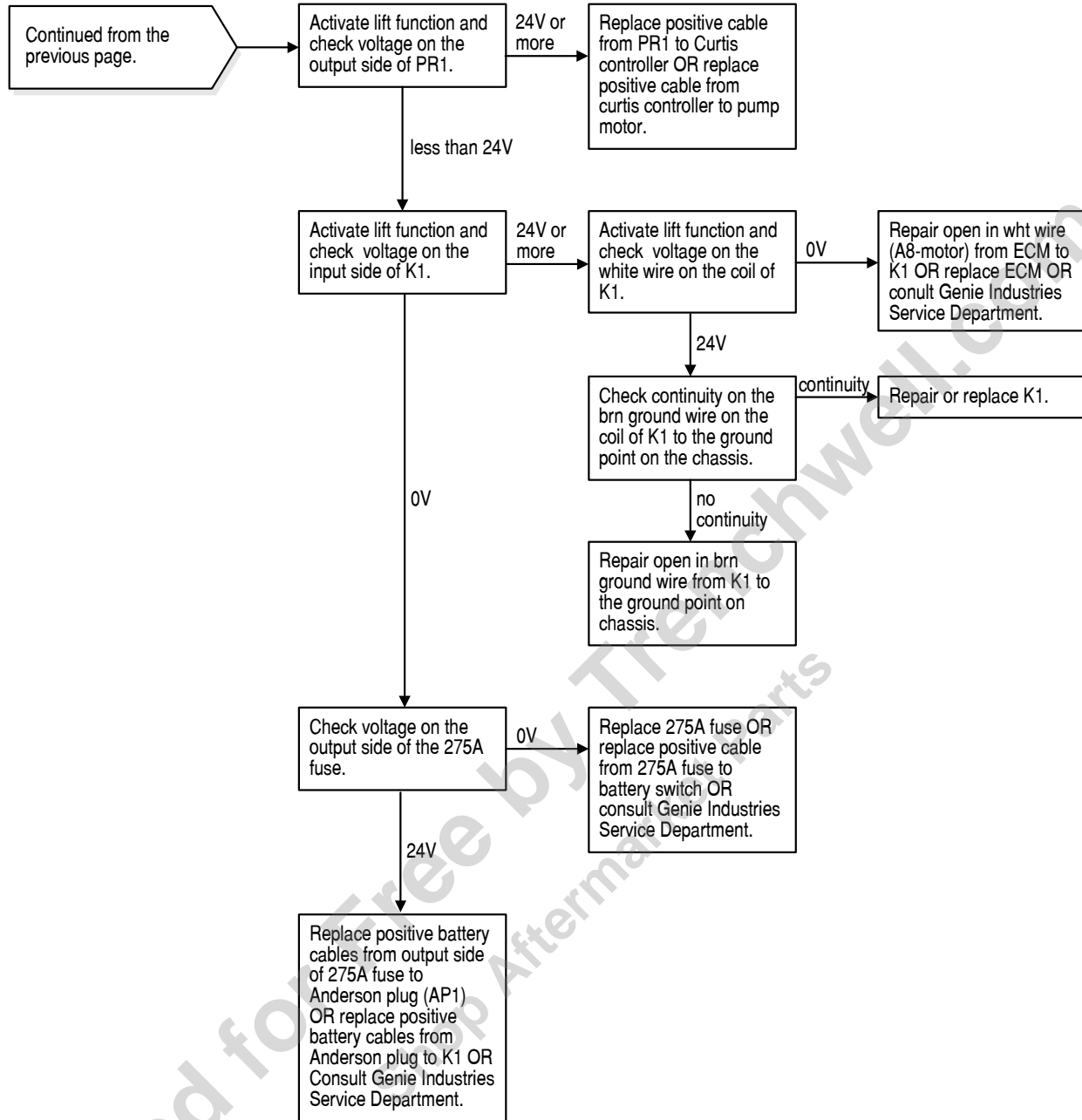

CHART 2



## Chart 3

### All Functions Inoperative, Power Unit Starts and Runs

Be sure, if the Error Indicator light is on at the platform controls, you refer to the specific chart that relates to the error code that is displayed on the ECM.

Be sure the circuit breaker and fuse are not tripped or blown.

Be sure the batteries are properly connected.

Be sure the batteries are fully charged.

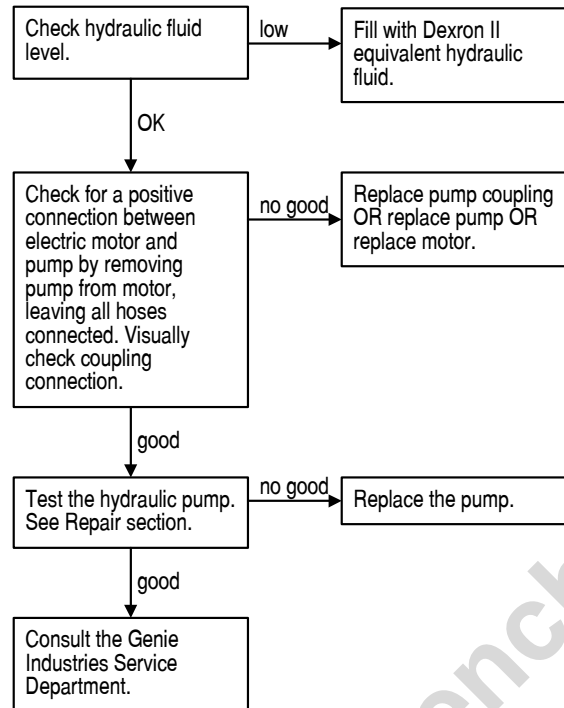

# Chart 4

## Ground Controls Inoperative, Platform Controls Operate Normally

Be sure, if the Error Indicator light is on at the platform controls, you refer to the specific chart that relates to the error code that is displayed on the ECM.

Be sure the circuit breaker and fuse are not tripped or blown.

Be sure the batteries are properly connected.

Be sure the batteries are fully charged.

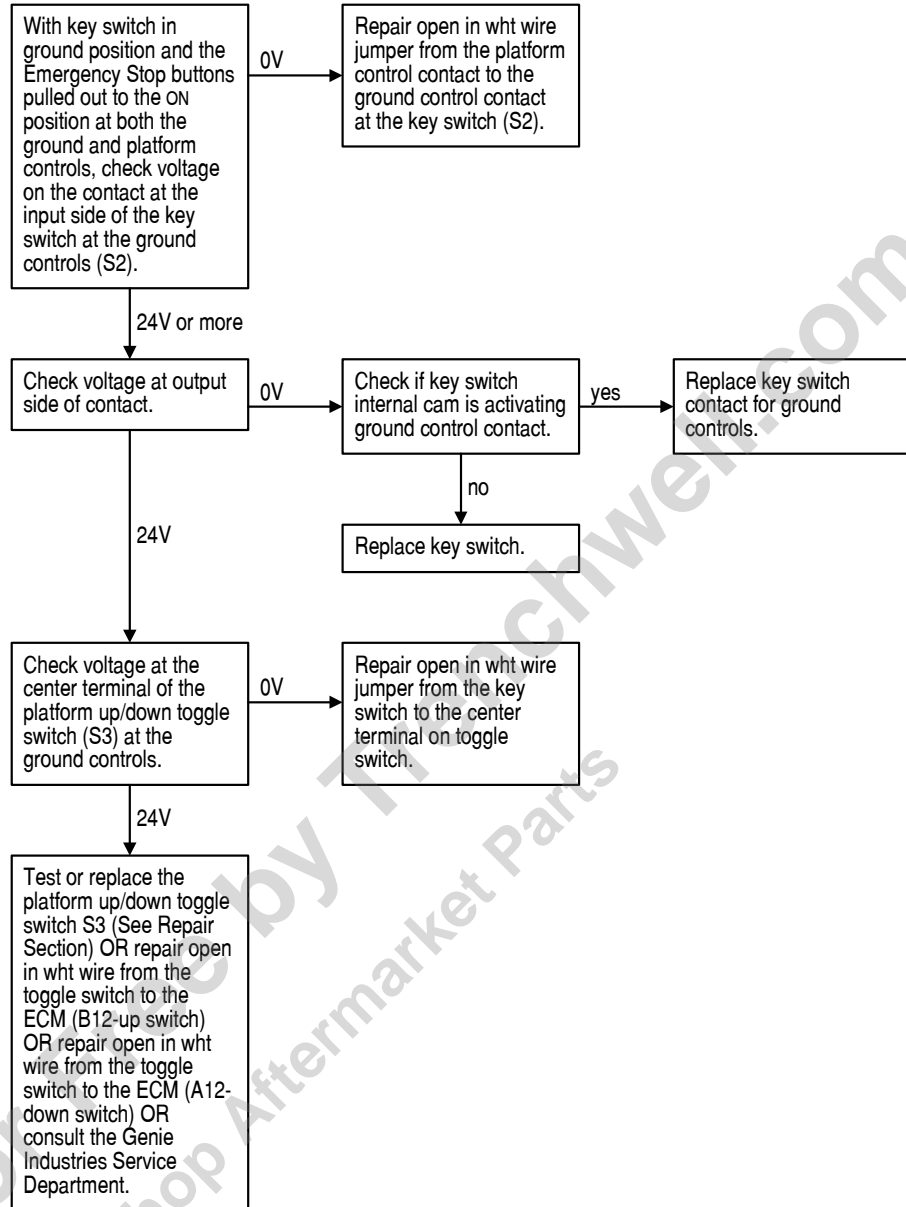

# Chart 5

## Platform Controls Inoperative, Ground Controls Operate Normally

Be sure, if the Error Indicator light is on at the platform controls, you refer to the specific chart that relates to the error code that is displayed on the ECM.

Be sure the circuit breaker and fuse are not tripped or blown.

Be sure the batteries are properly connected.

Be sure the batteries are fully charged.

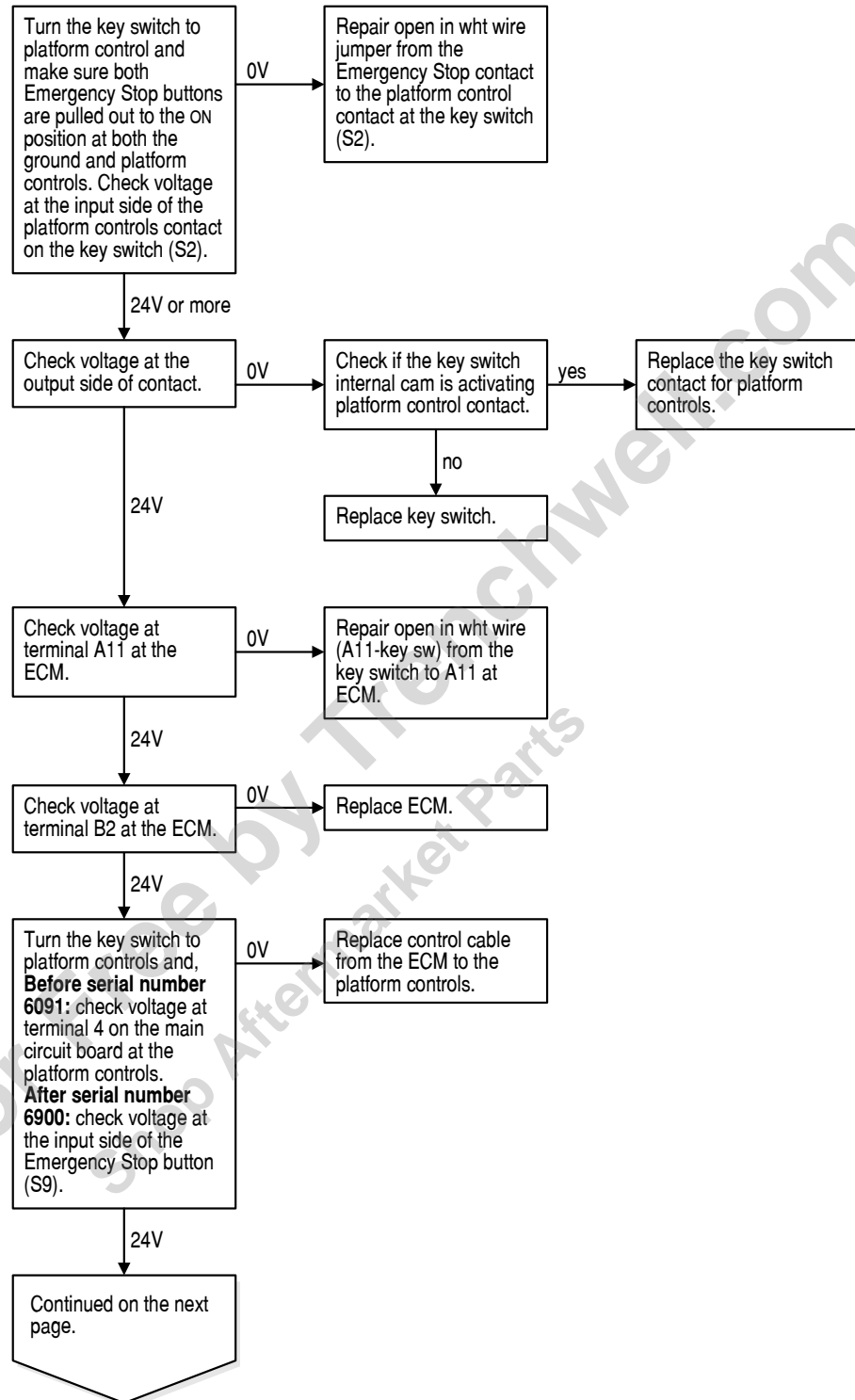
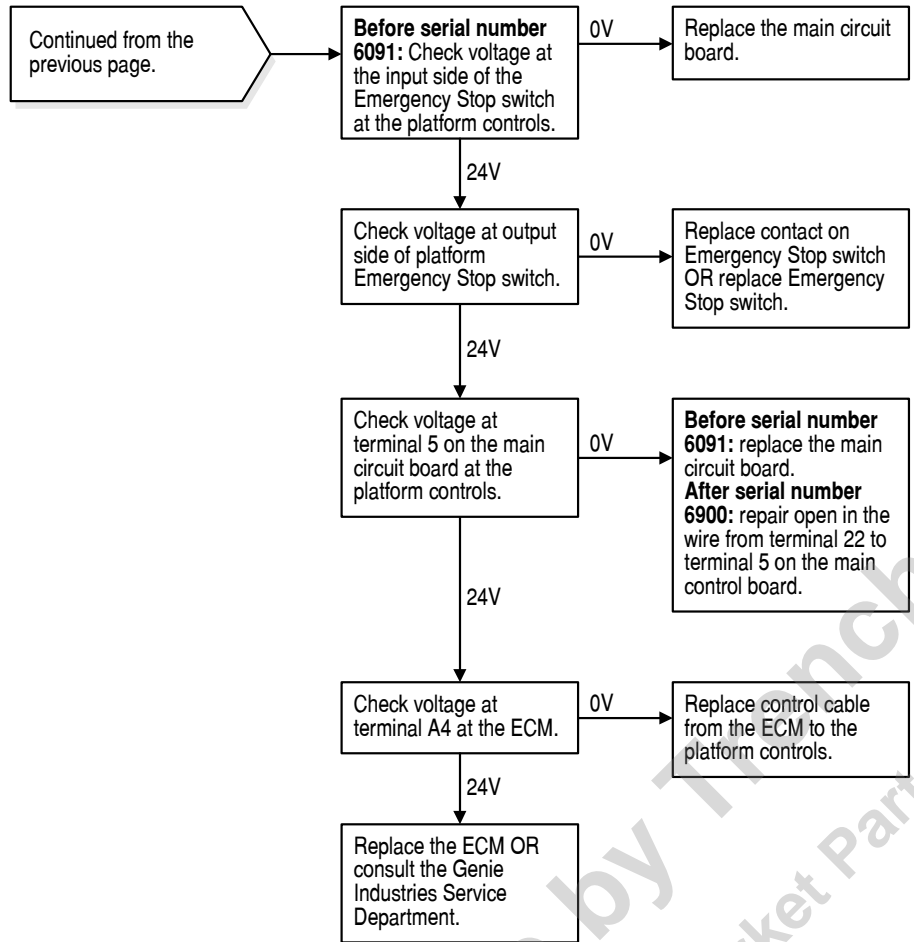

CHART 5



# Chart 6

## Platform Up Function Inoperative

Be sure all other functions operate normally.

Be sure the circuit breaker and fuse are not tripped or blown.

Be sure the batteries are properly connected.

Be sure the batteries are fully charged.

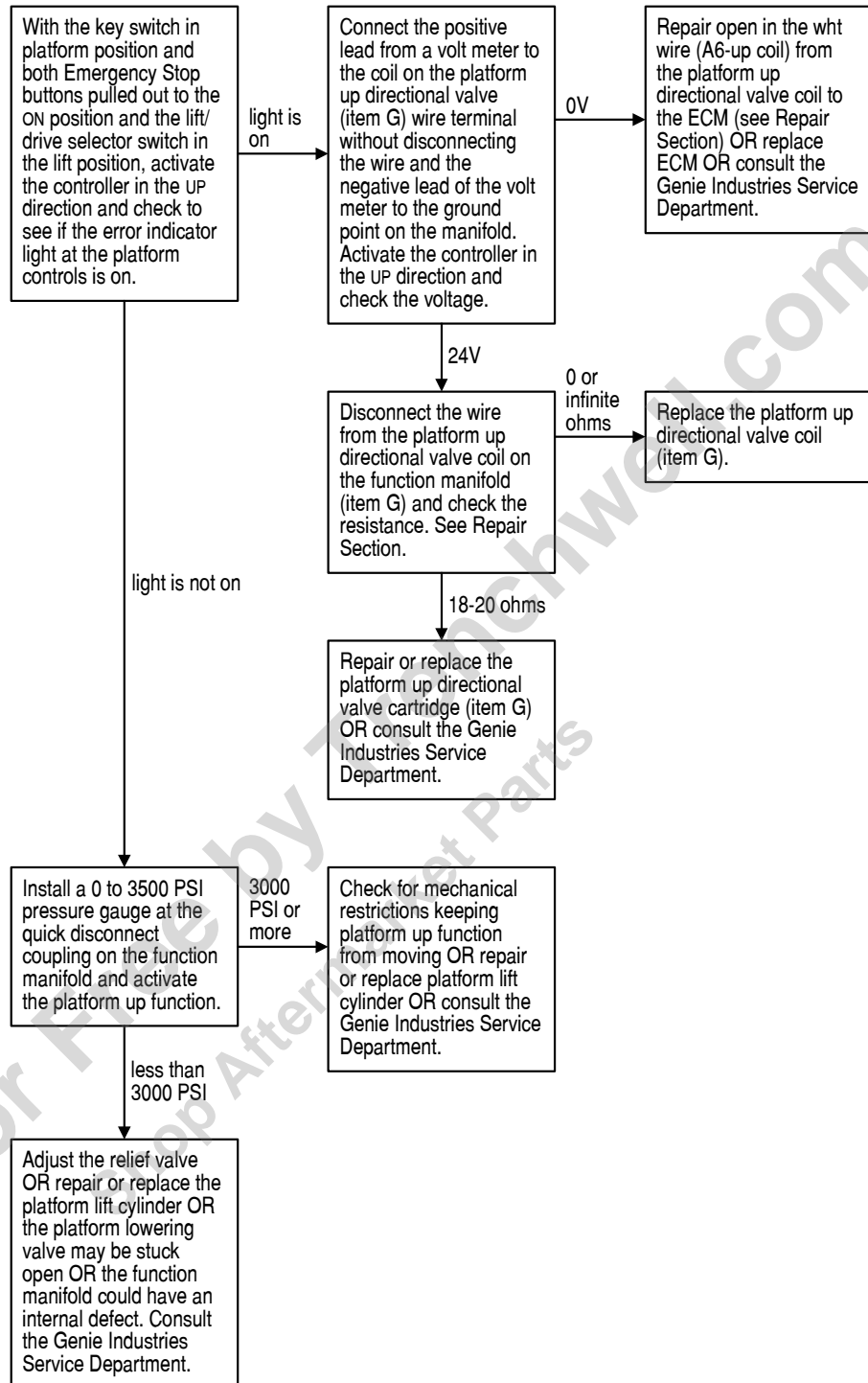

# Chart 7

## Platform Down Function Inoperative

Be sure all other functions operate normally.

Be sure the circuit breaker and fuse are not tripped or blown.

Be sure the batteries are properly connected.

Be sure the batteries are fully charged.

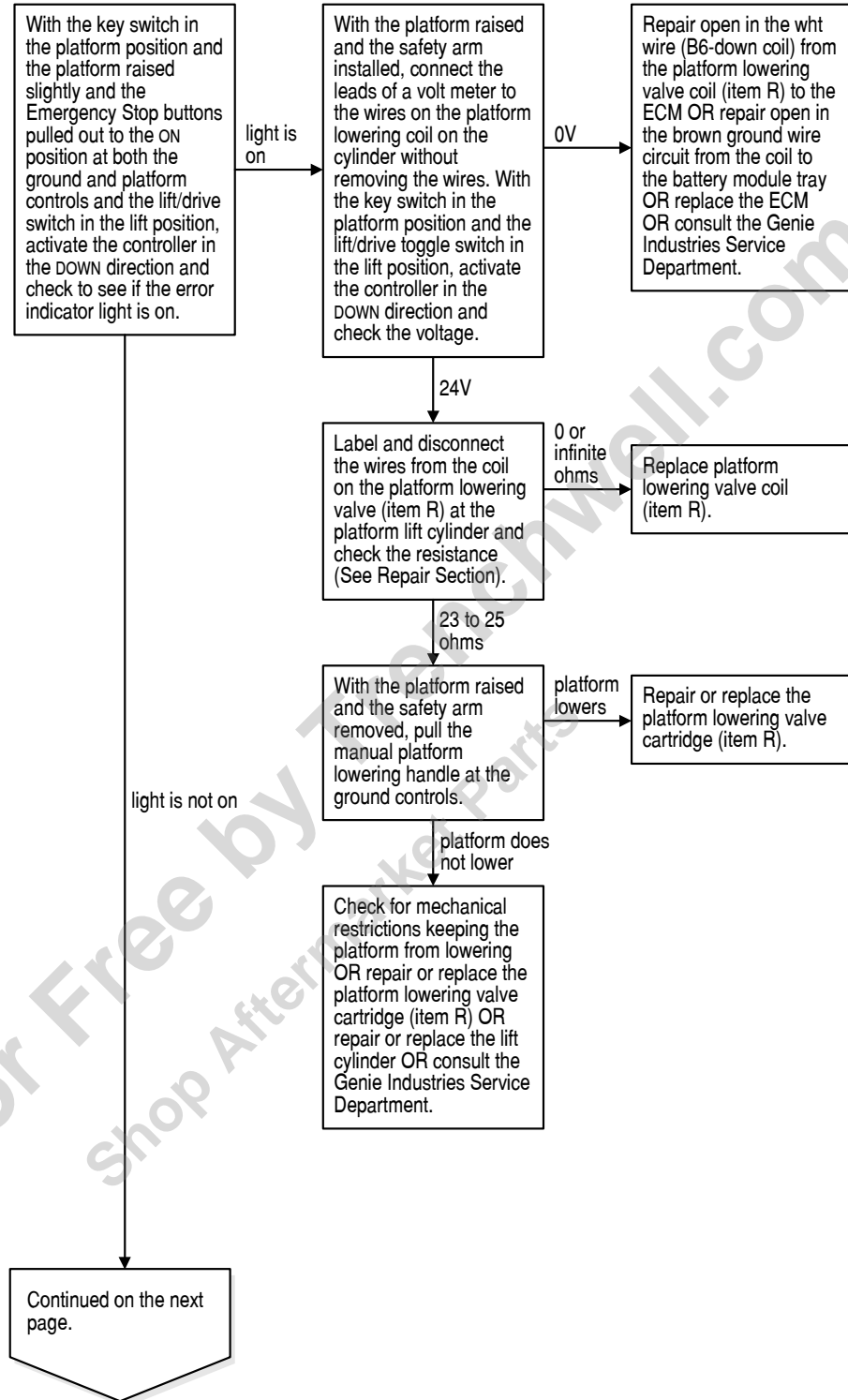
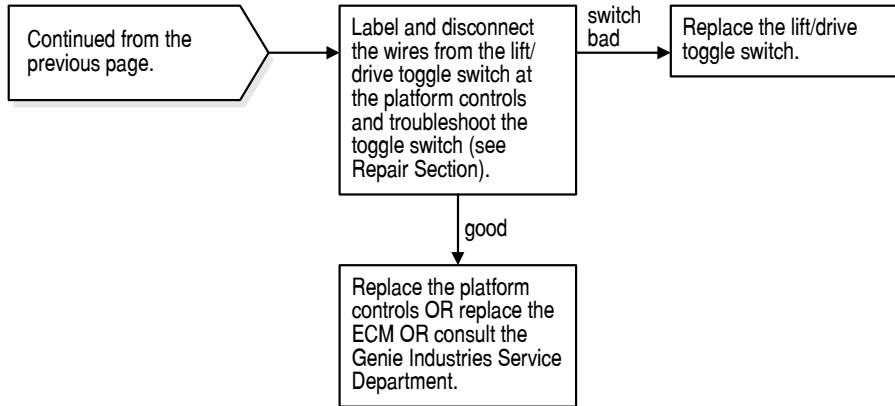

CHART 7



# Chart 8

## Steer Left Function Inoperative

Be sure all other functions operate normally.

Be sure the circuit breaker and fuse are not tripped or blown.

Be sure the batteries are properly connected.

Be sure the batteries are fully charged.

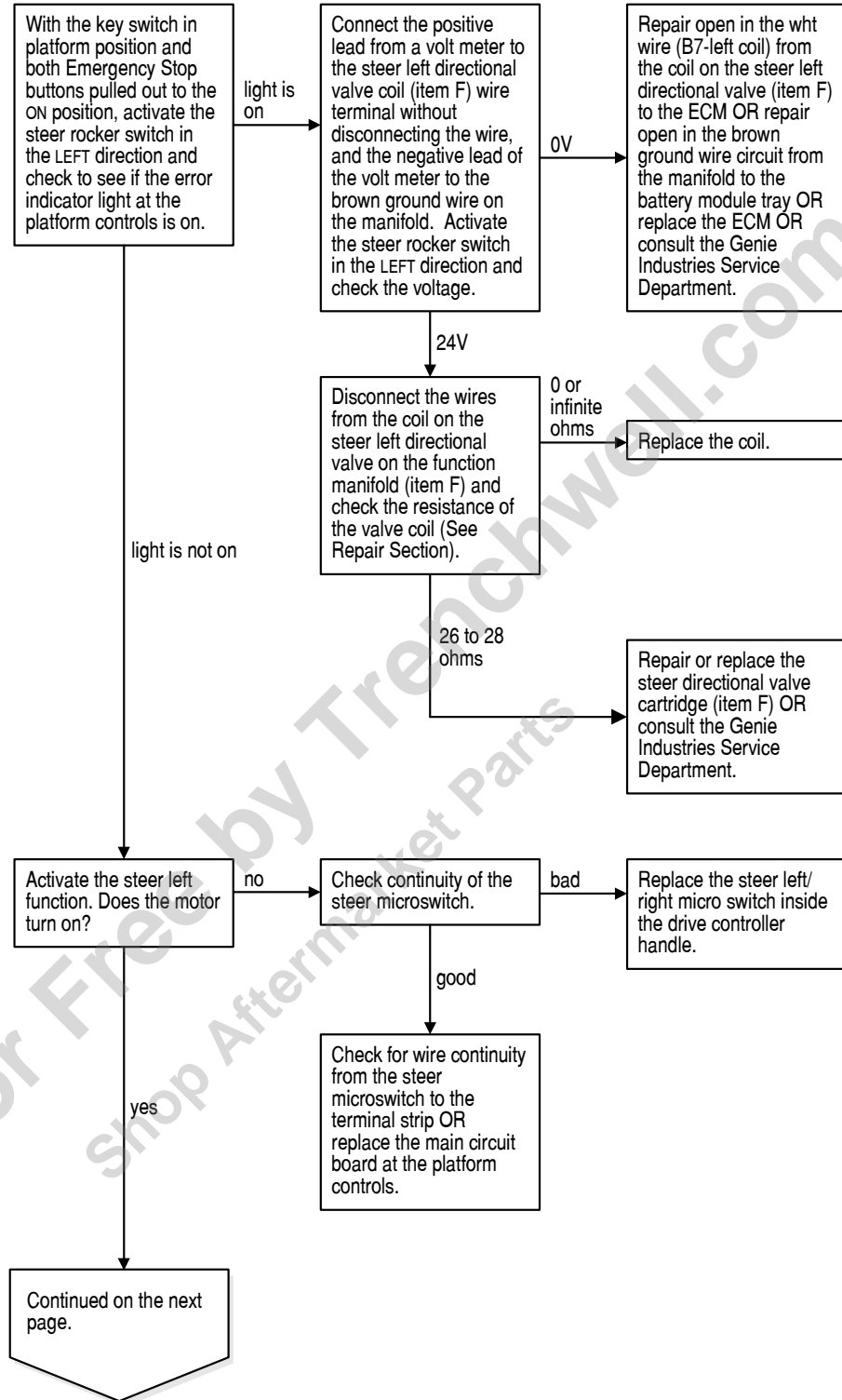
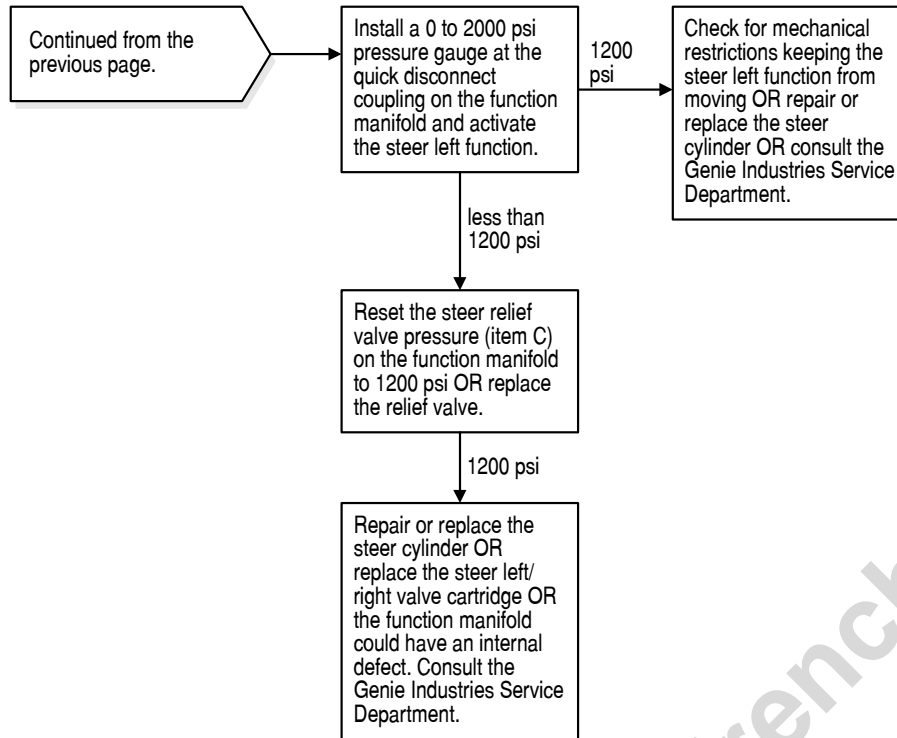

CHART 8



# Chart 9

## Steer Right Function Inoperative

Be sure all other functions operate normally.

Be sure the circuit breaker and fuse are not tripped or blown.

Be sure the batteries are properly connected.

Be sure the batteries are fully charged.

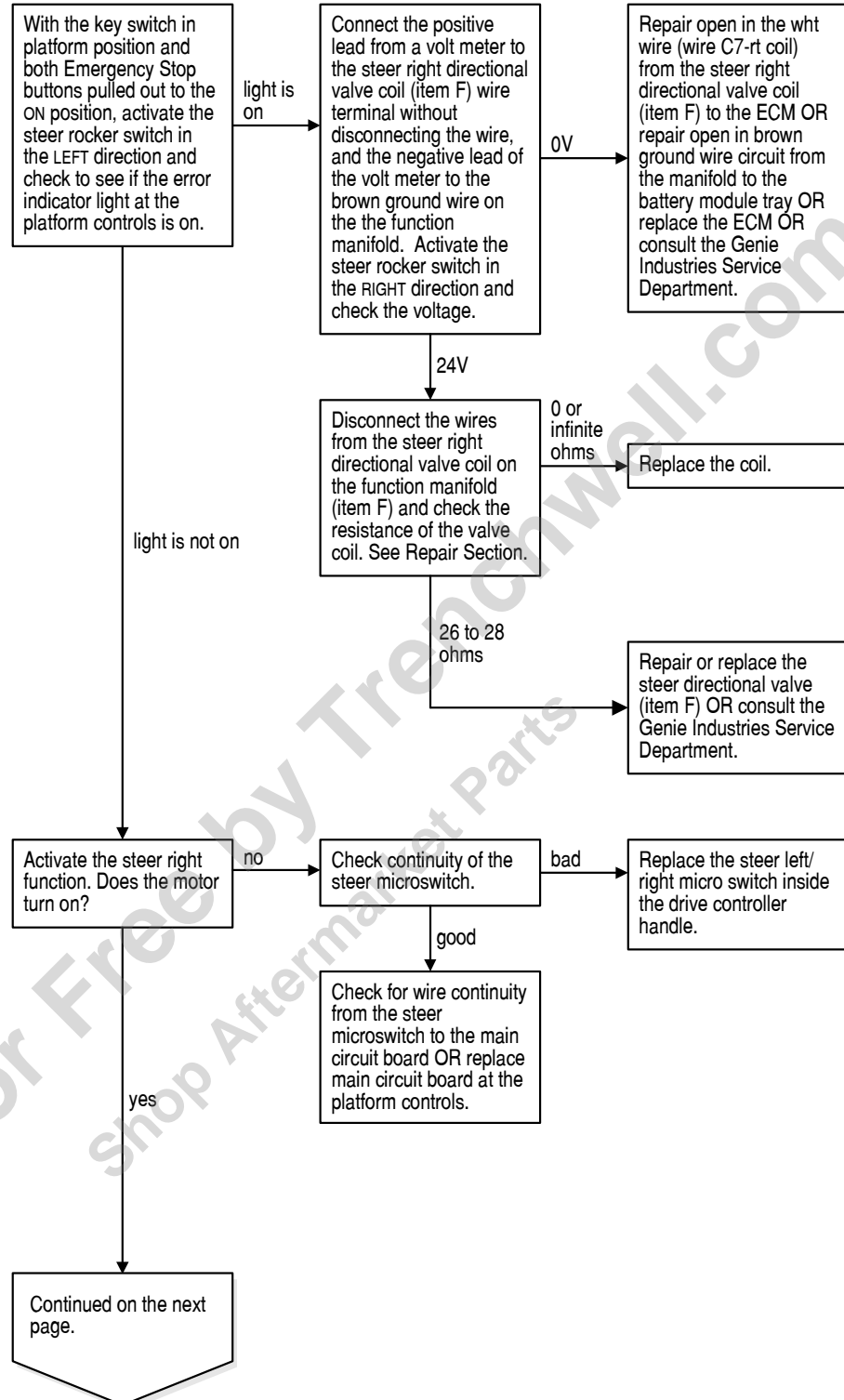
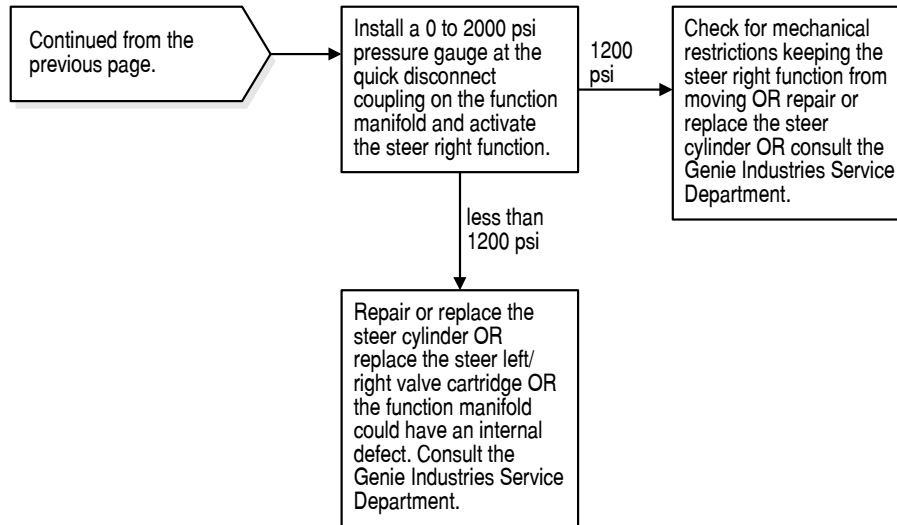

CHART 9



# Chart 10

## All Drive Functions Inoperative, All Other Functions Operate Normally

Be sure, if the Error Indicator light is on at the platform controls, you refer to the specific chart that relates to the error code that is displayed on the ECM.

Be sure the circuit breaker and fuse are not tripped or blown.

Be sure the batteries are properly connected.

Be sure the batteries are fully charged.

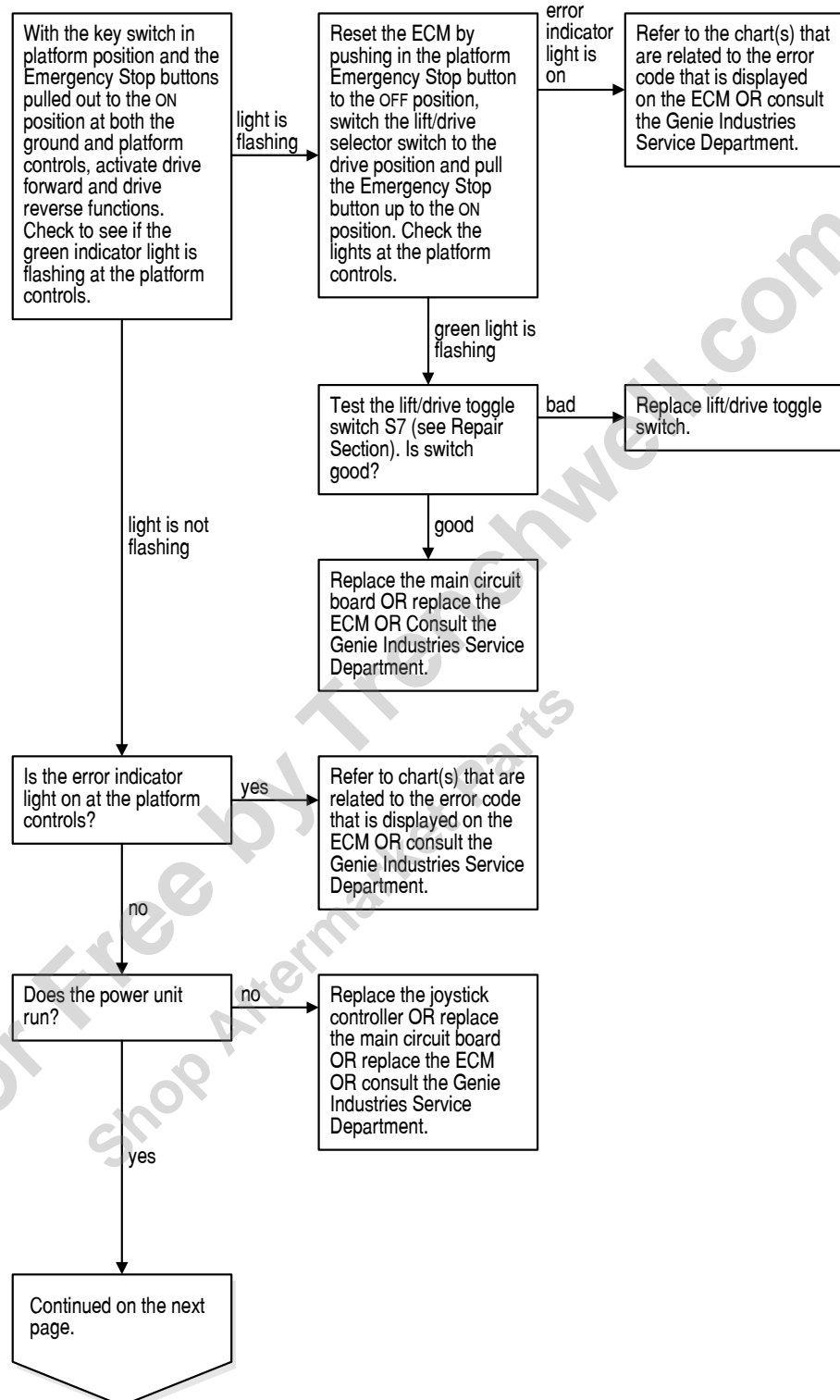
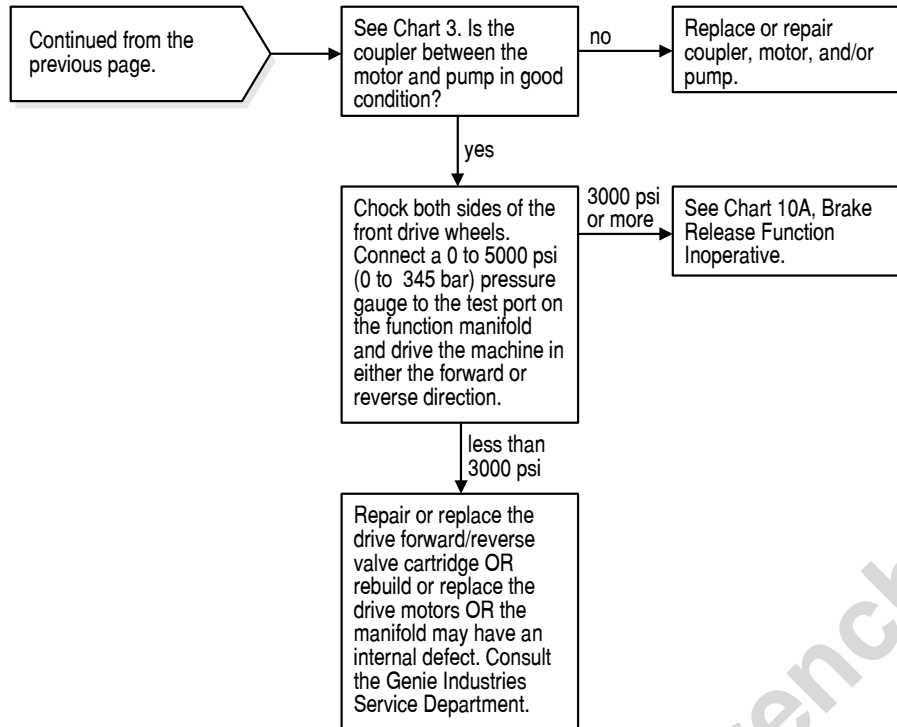

CHART 10



# Chart 10A

## Brake Release Function Inoperative

Be sure, if the Error Indicator light is on at the platform controls, you refer to the specific chart that relates to the error code that is displayed on the ECM.

Be sure the circuit breaker and fuse are not tripped or blown.

Be sure the batteries are properly connected.

Be sure the batteries are fully charged.

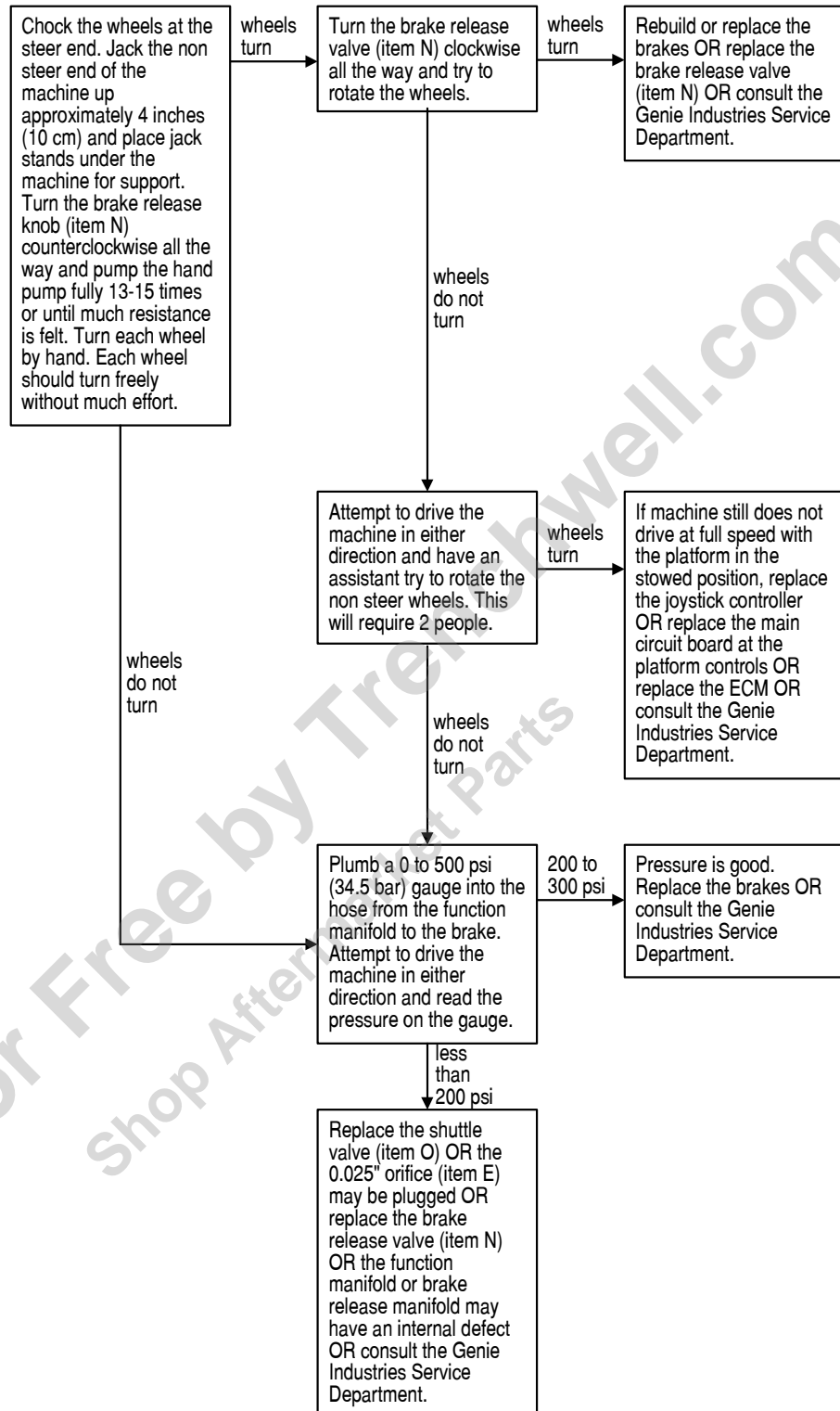

# Chart 11

## Drive Forward Function Inoperative

Be sure all other functions operate normally.

Be sure the circuit breaker and fuse are not tripped or blown.

Be sure the batteries are properly connected.

Be sure the batteries are fully charged.

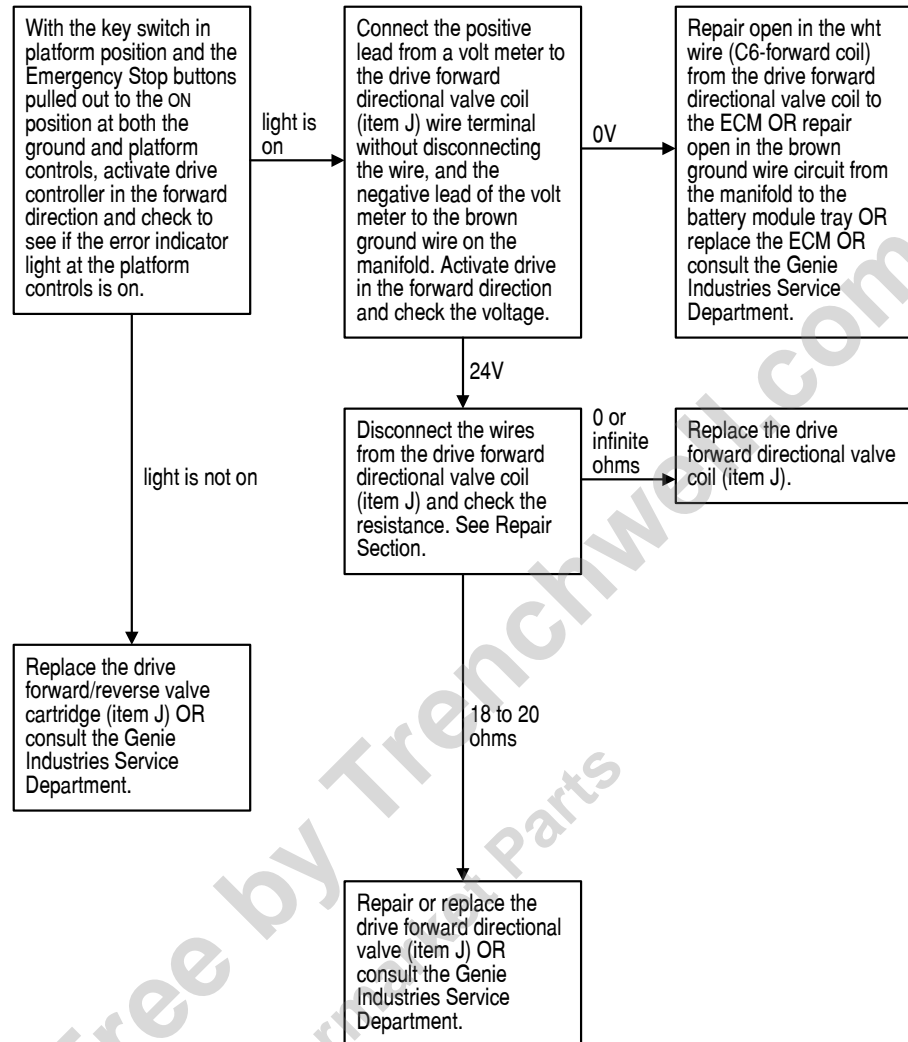

# Chart 12

## Drive Reverse Function Inoperative

Be sure all other functions operate normally.

Be sure the circuit breaker and fuse are not tripped or blown.

Be sure the batteries are properly connected.

Be sure the batteries are fully charged.

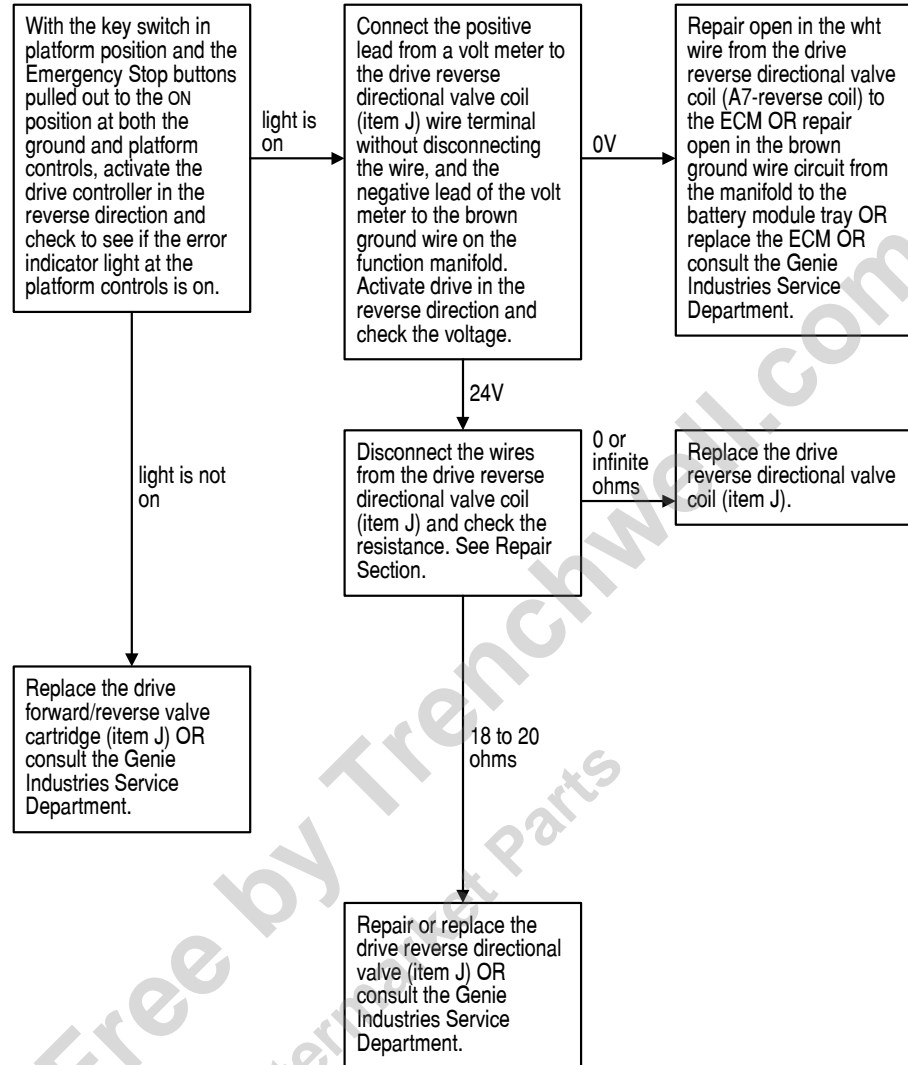

# Chart 13

## Machine Will Not Drive At Full Speed

Be sure the circuit breaker and fuse are not tripped or blown.

Be sure the batteries are properly connected.

Be sure the batteries are fully charged.

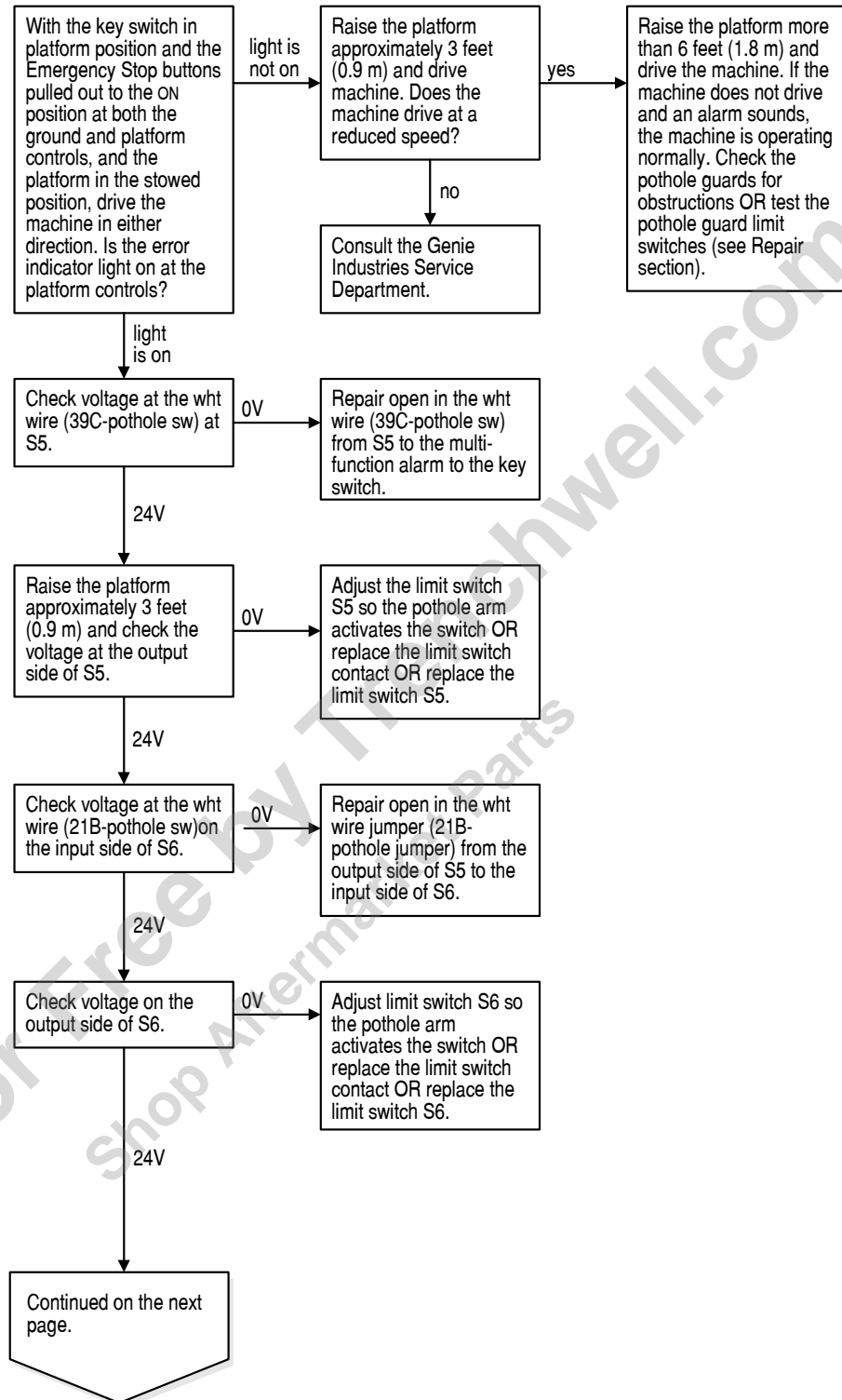
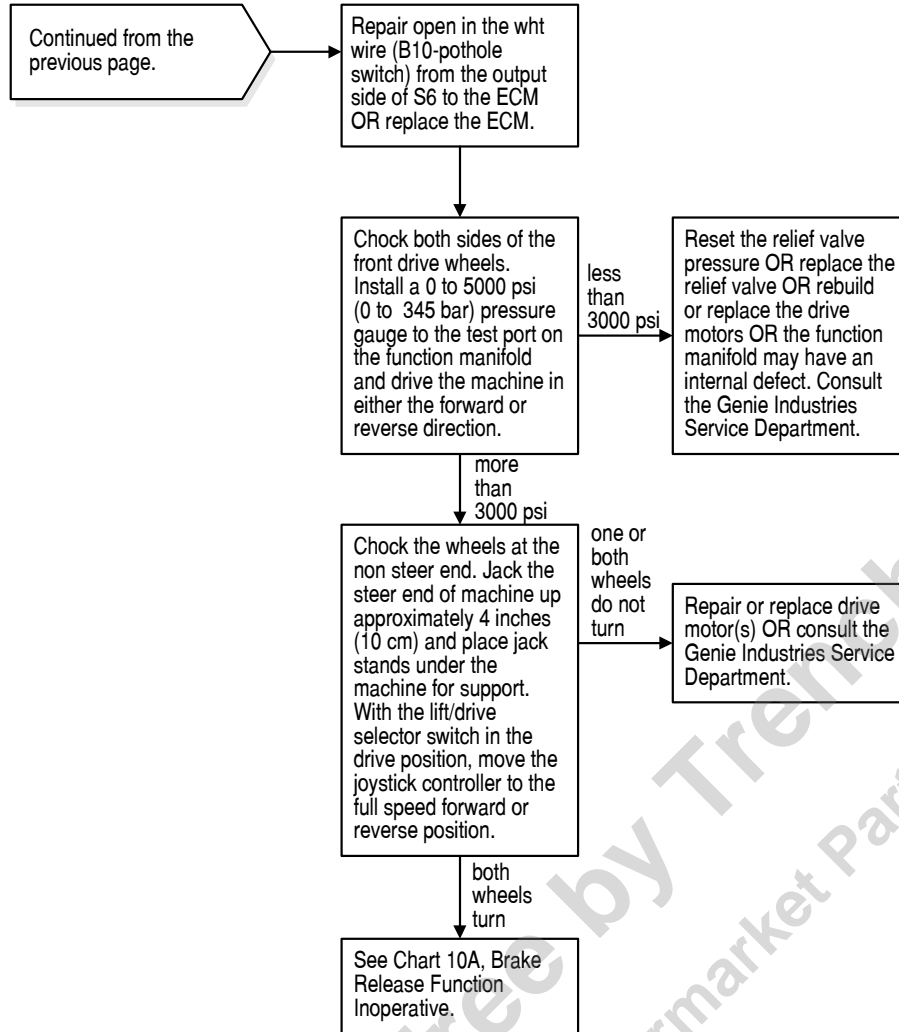

CHART 13



# Chart 14

## Machine Drives At Full Speed With Platform Raised

Be sure the circuit breaker and fuse are not tripped or blown.

Be sure the batteries are properly connected.

Be sure the batteries are fully charged.

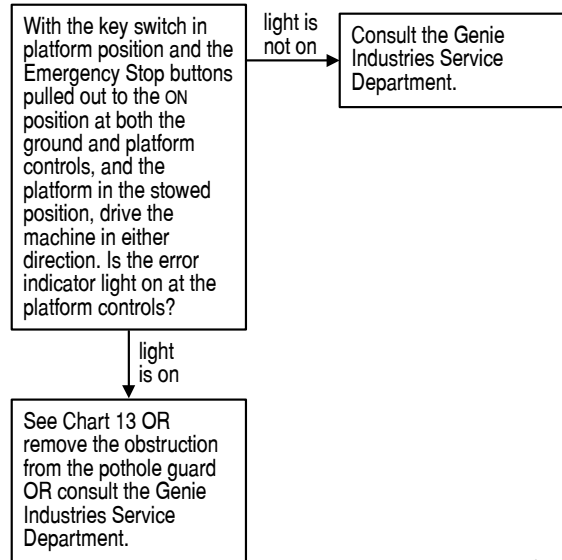

# Schematics



## Observe and Obey:

- ☑ Troubleshooting and repair procedures shall be completed by a person trained and qualified on the repair of this machine.
- ☑ Immediately tag and remove from service a damaged or malfunctioning machine.
- ☑ Repair any machine damage or malfunction before operating the machine.

## Before Troubleshooting:

- ☑ Read, understand and obey the safety rules and operating instructions printed in the *Genie GS-1530 & Genie GS-1930 Operator's Manual*.
- ☑ Be sure that all necessary tools and test equipment are available and ready for use.

## About This Section

There are two groups of schematics in this section. An illustration legend precedes each group of drawings.

### Electrical Schematics

**⚠WARNING** Electrocutation hazard. Contact with electrically charged circuits may result in death or serious injury. Remove all rings, watches and other jewelry.

### Hydraulic Schematics

**⚠WARNING** Bodily injury hazard. Spraying hydraulic oil can penetrate and burn skin. Loosen hydraulic connections very slowly to allow the oil pressure to dissipate gradually. Do not allow oil to squirt or spray.

### General Repair Process

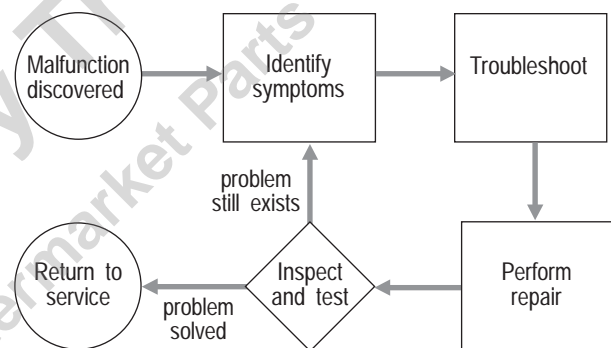

## Electrical Components

Item	Description	Genie Part Part Number	Manufacturer	Manufacturer Part Number	Qty
AP1	Anderson connector	19436	Anderson	6325-G1	2
B1	Alarm, steady tone	39540	Floyd Bell Inc.	UC-09628-Q	1
B2	Alarm, intermittent	18963	Floyd Bell Inc.	XB-09-630-Q	1
F1	Fuse, 275 amp	13104	Buss	ANN-275	1
F2	Circuit breaker	47811	ETA	45-700-IG1-P10	2
FB1	Flashing beacon	39676	ECCO Electronic Controls	6220A	2
G1	Battery, 255AH, 6V DC	46265	Dyno Battery Co.	GC2B, dry	8
H1	Hour meter	19506	ENM Corporation	T40A4508	1
K1	Relay, 180 amp	19550	Curtis Instruments	13220544	1
P2	Level sensor, Dual Axis	40836	Power Comp. of Midwest	L36	1
R1	Resistor, 75 Ohm	51590	Dale	RS-10-38, 75 Ohm	1
S1	Contact, N.C.	29732	Telemecanique	ZB2-BE102	1
S2	Contact - key switch, N.O.	45081	Telemecanique	ZB2-BE101	1
S3	Toggle switch, SPDT 3 position momentary	13037	Microswitch Control Inc.	1NT1-7	1
S4, S5, S6	Contact - limit switch, N.C.H.O.	19491	Telemecanique	XESP2051	3
S7	Toggle switch, DPDT 2 position maintained	44987	ITT Schadow.	220536	1
S9	Contact, N.C.	44990	Telemecanique	ZA2-BZ1026	1
S10	Contact, N.O.	44989	Telemecanique	ZA2-BZ1016	1
U2	Motor controller, 48V, 275 amp	39472	Curtis Instruments	1204-036	1
Y2, Y3, Y4	Coil, 20V DC with diode	39347	Hydra Power Systems	6309757	3
Y5, Y6, Y8	Coil, 20V DC with diode	44176	Hydra Power Systems	6359752	3
Y7	Coil, 20V DC	44787	Hydra Power Systems	10166-25	1

### Module Tray Legend

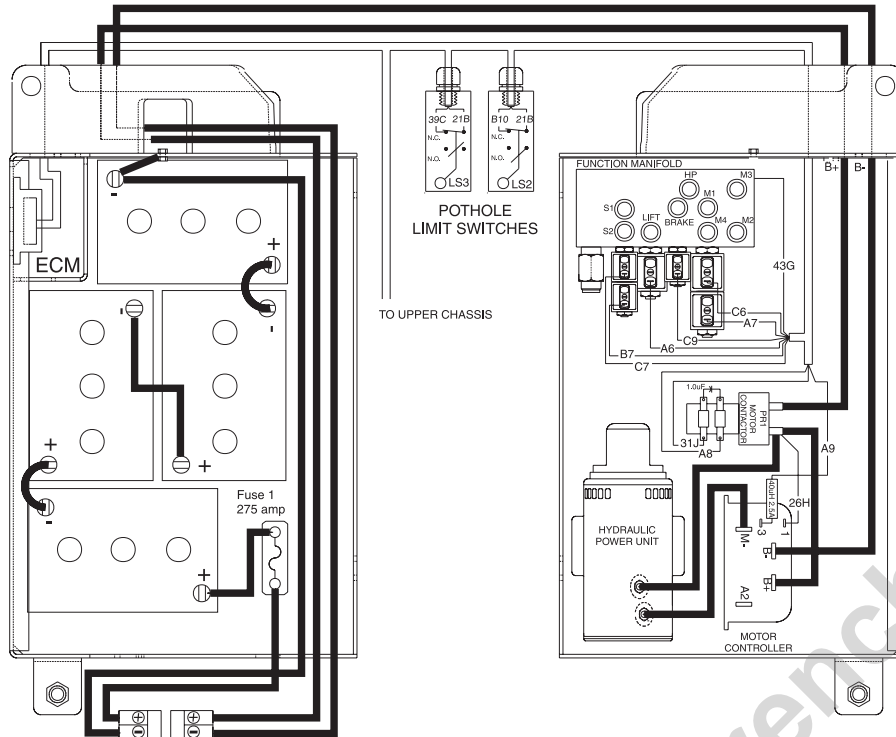

**Module Tray Legend**  
(models before serial number 6901)

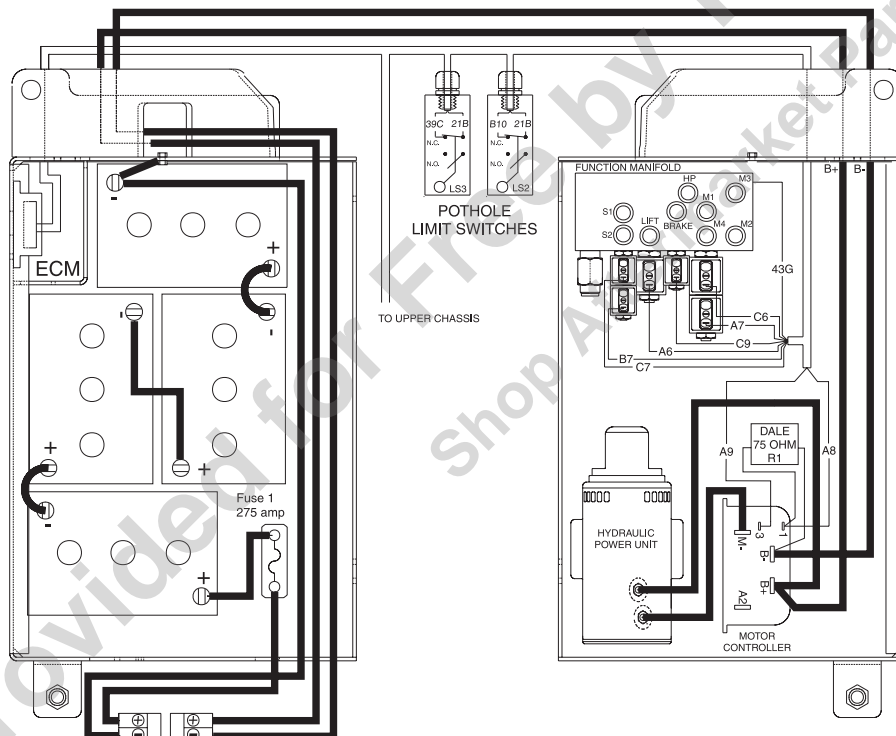

**Module Tray Legend**  
(models after serial number 6900)

# Electrical Symbols Legend

Wire with description	Solenoid or relay coil	Ground suppression circuit	Toggle switch SPDT
Terminal	Horn	Pothole switch	Solenoid valve
Flashing beacon	Alarm	Down limit switch normally closed	Key switch
T-circuits connect at terminal	Tilt sensor	Horn button normally open	Relay
T-circuits connect	Motor controller	Emergency Stop button normally closed	Fuse
Connection no terminal	Connector	1KΩ POT	1K Ohm Potentiometer
Circuits crossing no connection	Limit switch normally closed	Hour meter	Hour meter
Diode			
6V Battery			

Provided for Free by Trenchwell.com  
Shop Aftermarket Parts

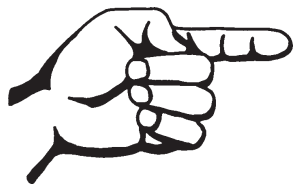

### Electrical Schematic (models before serial number 6901)

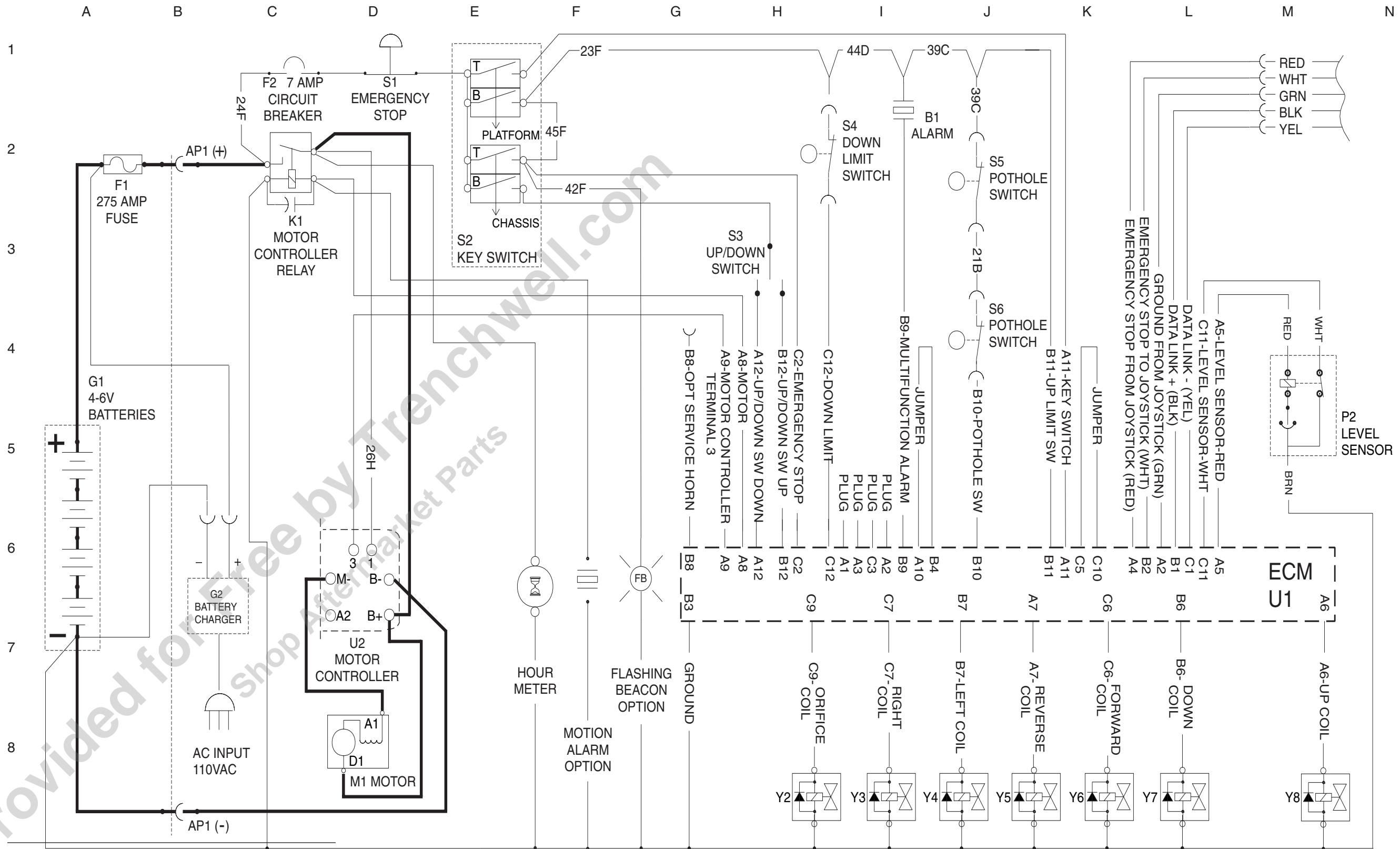

**Electrical Schematic  
(models before serial number 6901)**

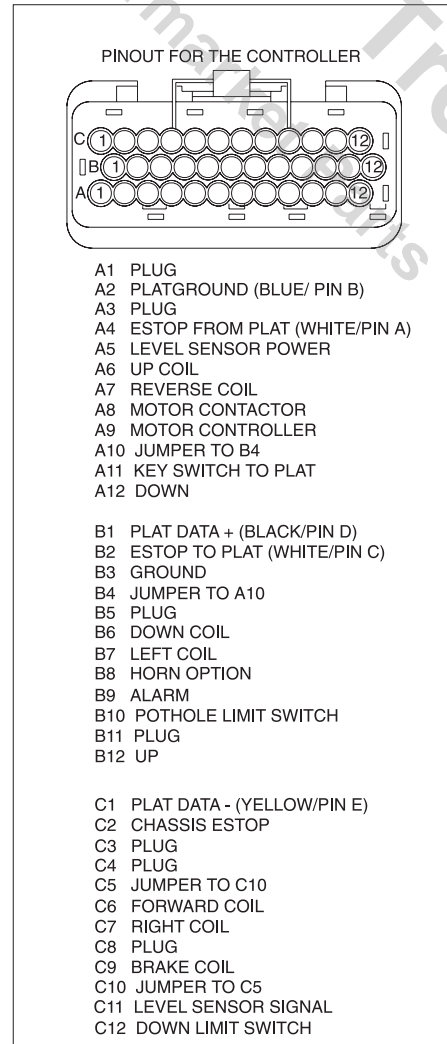
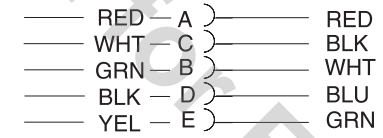
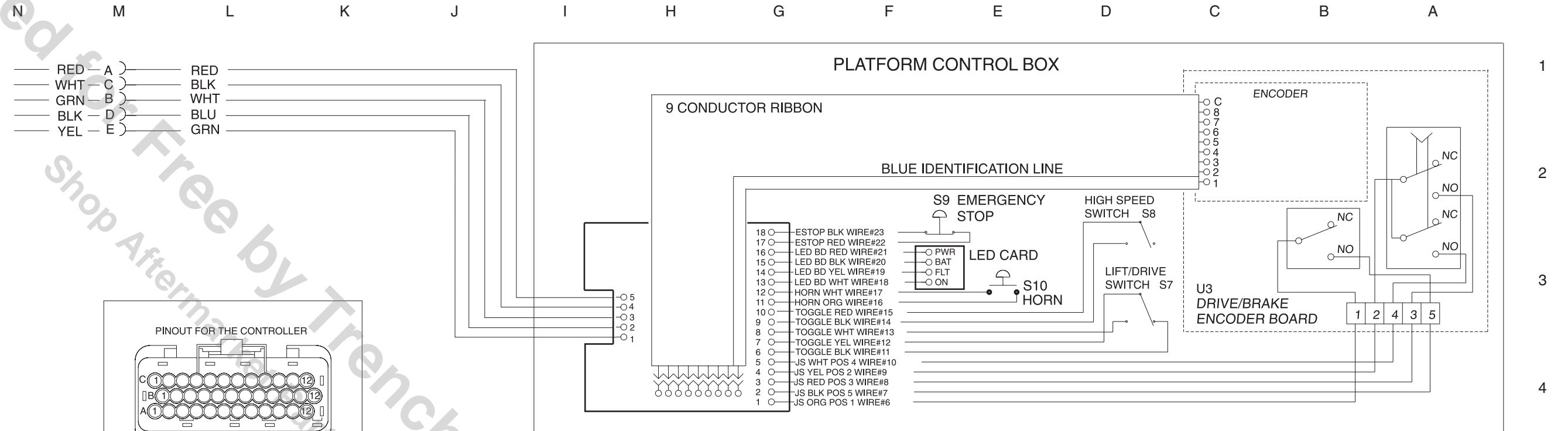

LEGEND			
DES	COMPONENT	DES	COMPONENT
AP1	ANDERSON PLUG	S8	HIGH SPEED SWITCH
B1	MULTIFUNCTION ALARM	S9	PLATFORM EMERGENCY STOP
F1	275 AMP FUSE	S10	HORN BUTTON
F2	7A CIRCUIT BREAKER	U1	CHASSIS CONTROLLER
G1	BATTERIES (4-6 VOLT)	U2	MOTOR CONTROLLER
G2	BATTERY CHARGER	U3	DRIVE/BRAKE ENCODER BOARD
P1	OPTIONAL HOUR METER	Y2	ORIFICE COIL
P2	LEVEL SENSOR	Y3	RIGHT TURN COIL
S1	CHSSIS EMERGENCY STOP	Y4	LEFT TURN COIL
S2	CHASSIS KEY SWITCH	Y5	REVERSE COIIL
S3	CHASSIS UP/DOWN SWITCH	Y6	FORWARD COIL
S4	DOWN LIMIT SWITCH	Y7	DOWN COIL
S5	POTHOLE SWITCH	Y8	UP COIL
S6	POTHOLE SWITCH		
S7	DRIVE/LIFT SELECTOR SWITCH		

---

**Electrical Schematic**  
**(models before serial number 6901)**

Provided for Free by Trenchwell.com  
Shop Aftermarket Parts

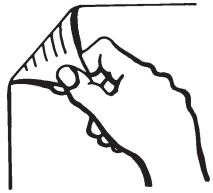

Provided for Free by Trenchwell.com  
Shop Aftermarket Parts

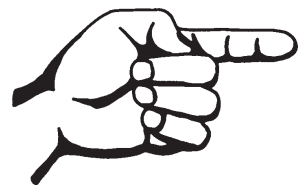

### Electrical Schematic (models from serial number 6901 to 8931)

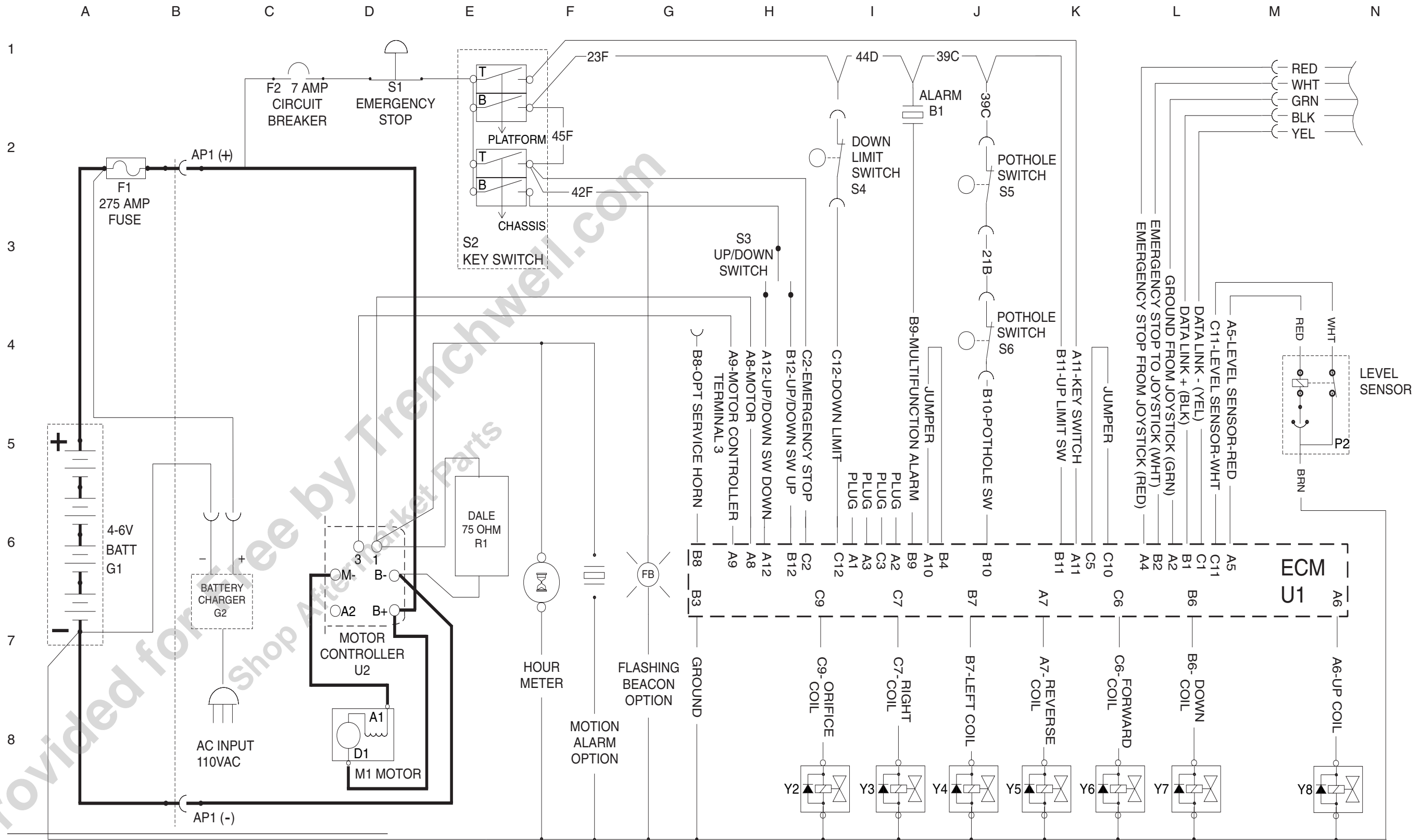

**Electrical Schematic  
(models from serial number 6901 to 8931)**

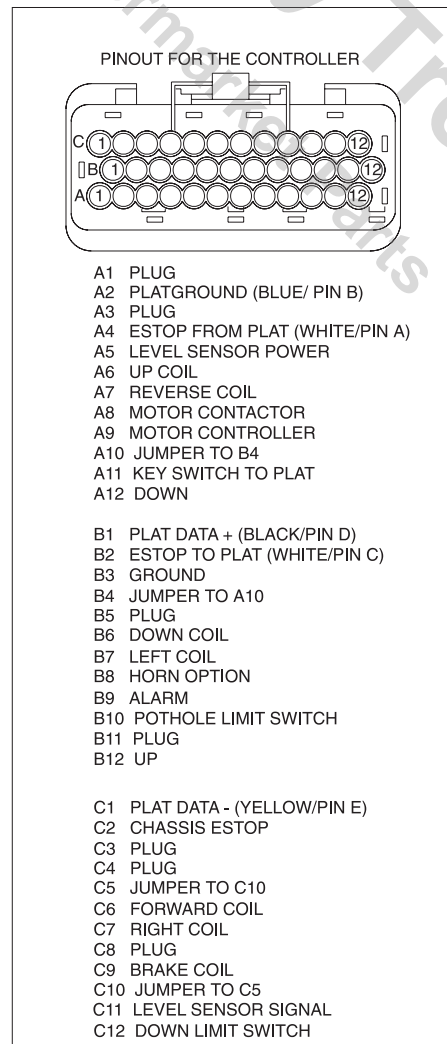
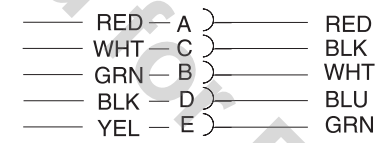
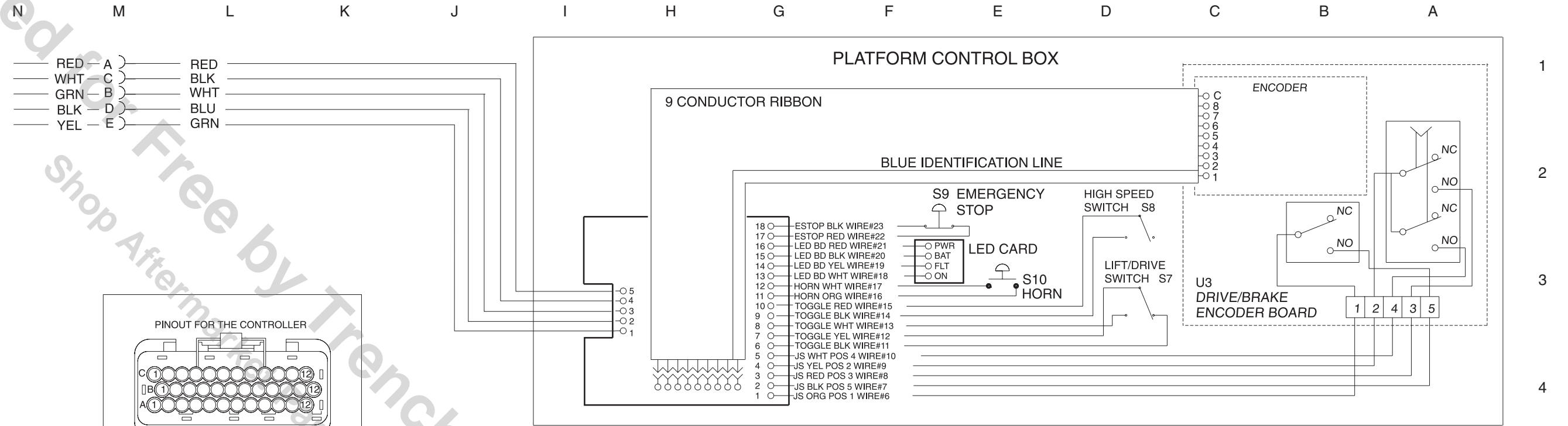

LEGEND			
DES	COMPONENT	DES	COMPONENT
AP1	ANDERSON PLUG	S8	HIGH SPEED SWITCH
B1	MULTIFUNCTION ALARM	S9	PLATFORM EMERGENCY STOP
F1	275 AMP FUSE	S10	HORN BUTTON
F2	7A CIRCUIT BREAKER	U1	CHASSIS CONTROLLER
G1	BATTERIES (4-6 VOLT)	U2	MOTOR CONTROLLER
G2	BATTERY CHARGER	U3	DRIVE/BRAKE ENCODER BOARD
P1	OPTIONAL HOUR METER	Y2	ORIFICE COIL
P2	LEVEL SENSOR	Y3	RIGHT TURN COIL
S1	CHSSIS EMERGENCY STOP	Y4	LEFT TURN COIL
S2	CHASSIS KEY SWITCH	Y5	REVERSE COIIL
S3	CHASSIS UP/DOWN SWITCH	Y6	FORWARD COIL
S4	DOWN LIMIT SWITCH	Y7	DOWN COIL
S5	POTHOLE SWITCH	Y8	UP COIL
S6	POTHOLE SWITCH		
S7	DRIVE/LIFT SELECTOR SWITCH		

---

**Electrical Schematic**  
**(models from serial number 6901 to 8931)**

Provided for Free by Trenchwell.com  
Shop Aftermarket Parts

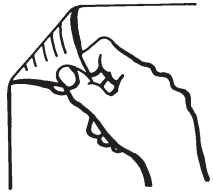

Provided for Free by Trenchwell.com  
Shop Aftermarket Parts

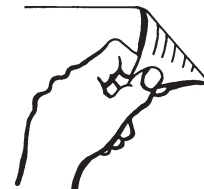
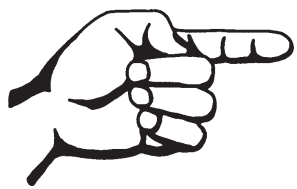

### Electrical Schematic (models after serial number 8931)

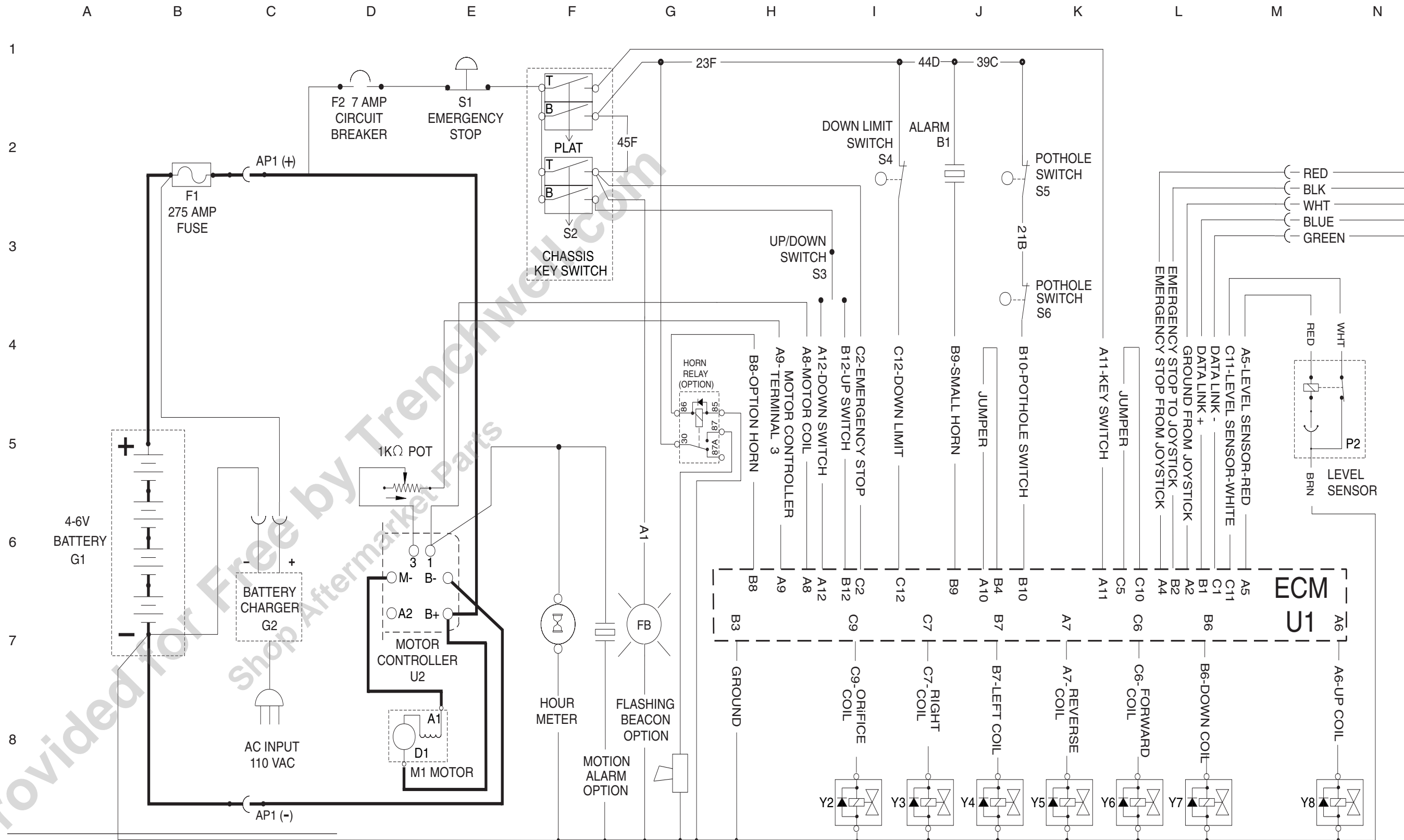

**Electrical Schematic  
(models after serial number 8931)**

N M L K J I H G F E D C B A

PLATFORM CONTROL BOX

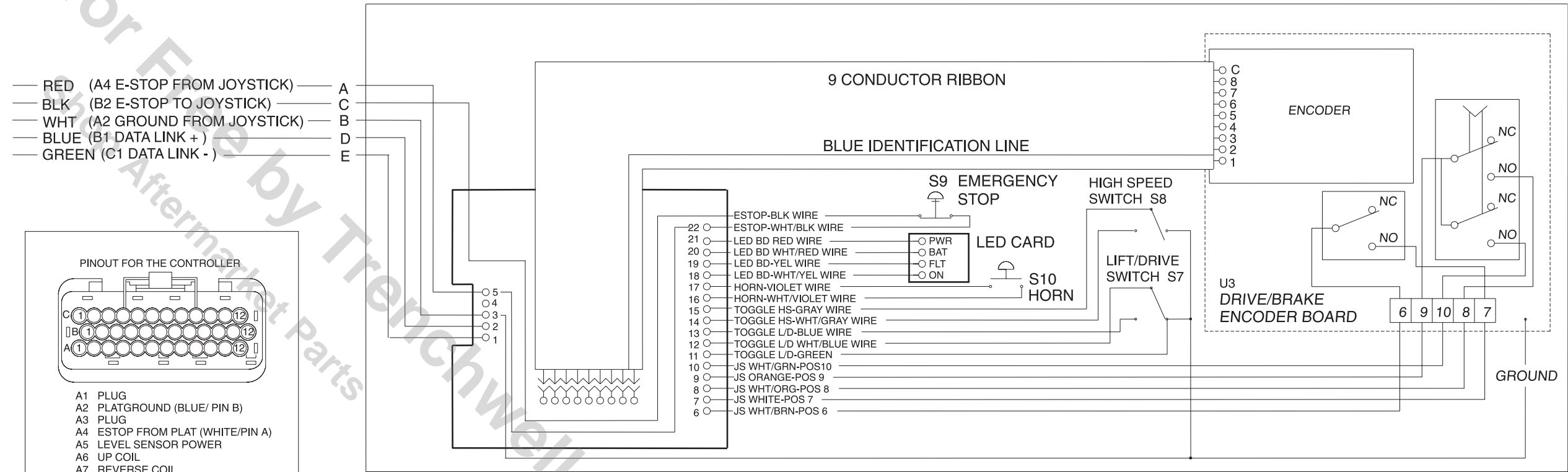

- RED (A4 E-STOP FROM JOYSTICK) — A
- BLK (B2 E-STOP TO JOYSTICK) — C
- WHT (A2 GROUND FROM JOYSTICK) — B
- BLUE (B1 DATA LINK +) — D
- GREEN (C1 DATA LINK -) — E

**PINOUT FOR THE CONTROLLER**

- A1 PLUG
- A2 PLATGROUND (BLUE/PIN B)
- A3 PLUG
- A4 ESTOP FROM PLAT (WHITE/PIN A)
- A5 LEVEL SENSOR POWER
- A6 UP COIL
- A7 REVERSE COIL
- A8 MOTOR CONTACTOR
- A9 MOTOR CONTROLLER
- A10 JUMPER TO B4
- A11 KEY SWITCH TO PLAT
- A12 DOWN
- B1 PLAT DATA + (BLACK/PIN D)
- B2 ESTOP TO PLAT (WHITE/PIN C)
- B3 GROUND
- B4 JUMPER TO A10
- B5 PLUG
- B6 DOWN COIL
- B7 LEFT COIL
- B8 HORN OPTION
- B9 ALARM
- B10 POTHOLE LIMIT SWITCH
- B11 PLUG
- B12 UP
- C1 PLAT DATA - (YELLOW/PIN E)
- C2 CHASSIS ESTOP
- C3 PLUG
- C4 PLUG
- C5 JUMPER TO C10
- C6 FORWARD COIL
- C7 RIGHT COIL
- C8 PLUG
- C9 BRAKE COIL
- C10 JUMPER TO C5
- C11 LEVEL SENSOR SIGNAL
- C12 DOWN LIMIT SWITCH

LEGEND			
DES	COMPONENT	DES	COMPONENT
AP1	ANDERSON PLUG	S8	HIGH SPEED SWITCH
B1	MULTIFUNCTION ALARM	S9	PLATFORM EMERG STOP
F1	275 AMP FUSE	S10	HORN BUTTON
F2	7 AMP CIRCUIT BREAKER	U1	CHASSIS CONTROLLER
G1	BATTERIES (4-6 VOLT)	U2	MOTOR CONTROLLER
G2	BATTERY CHARGER	U3	DRIVE/BRAKE ENCODER BOARD
P1	OPTIONAL HOUR METER	Y2	ORIFICE COIL
P2	LEVEL SENSOR	Y3	RIGHT TURN COIL
S1	CHASSIS EMERGENCY STOP	Y4	LEFT TURN COIL
S2	CHASSIS KEY SWITCH	Y5	REVERSE COIL
S3	CHASSIS UP/DOWN SWITCH	Y6	FORWARD COIL
S4	DOWN LIMIT SWITCH	Y7	DOWN COIL
S5	POTHOLE SWITCH	Y8	UP COIL
S6	POTHOLE SWITCH		
S7	LIFT/DRIVE SELECTOR SWITCH		

---

**Electrical Schematic**  
**(models after serial number 8931)**

Provided for Free by Trenchwell.com  
Shop Aftermarket Parts

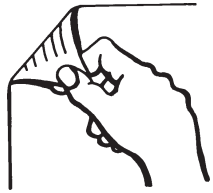

### Ground Controls and Level Sensor Box Legend

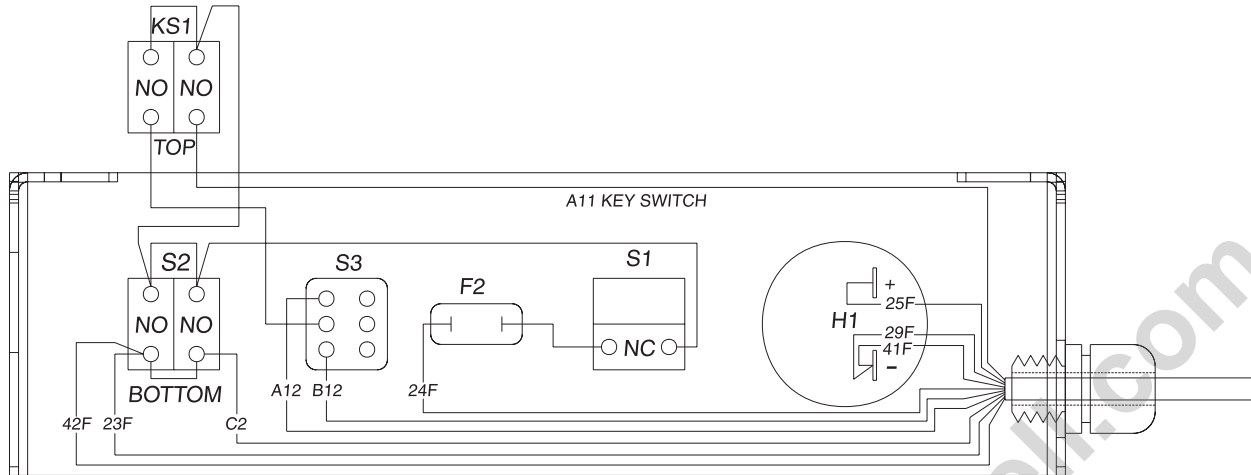

GROUND CONTROL BOX

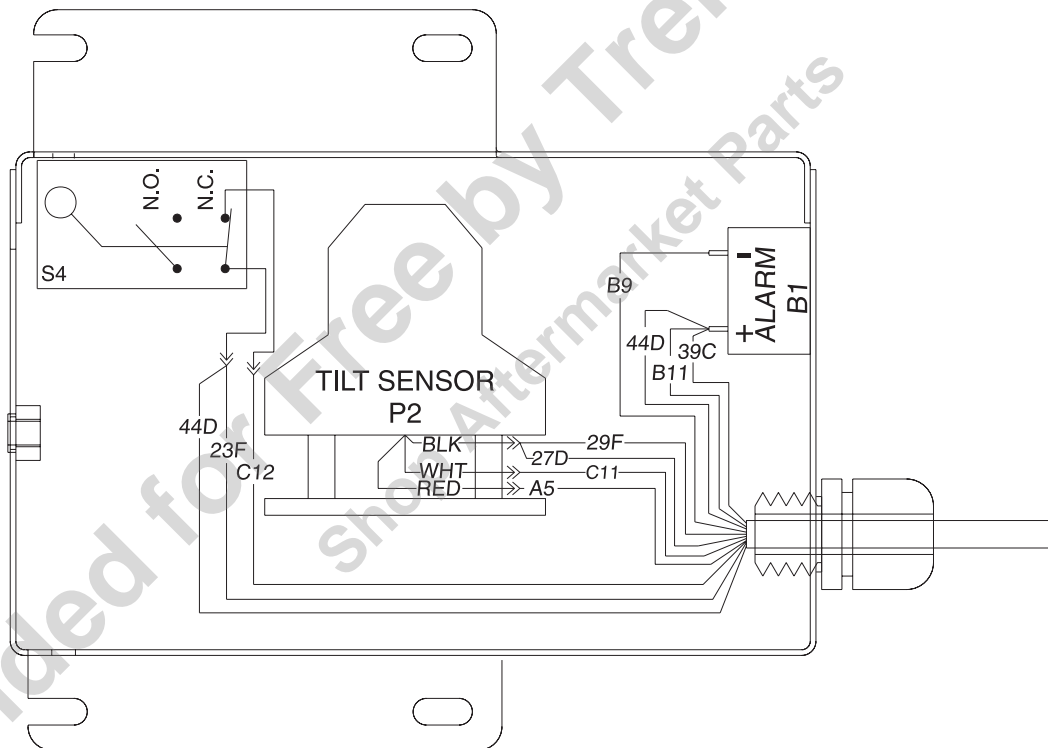

LEVEL SENSOR BOX

### Platform Controls Legend (models before serial number 17408)

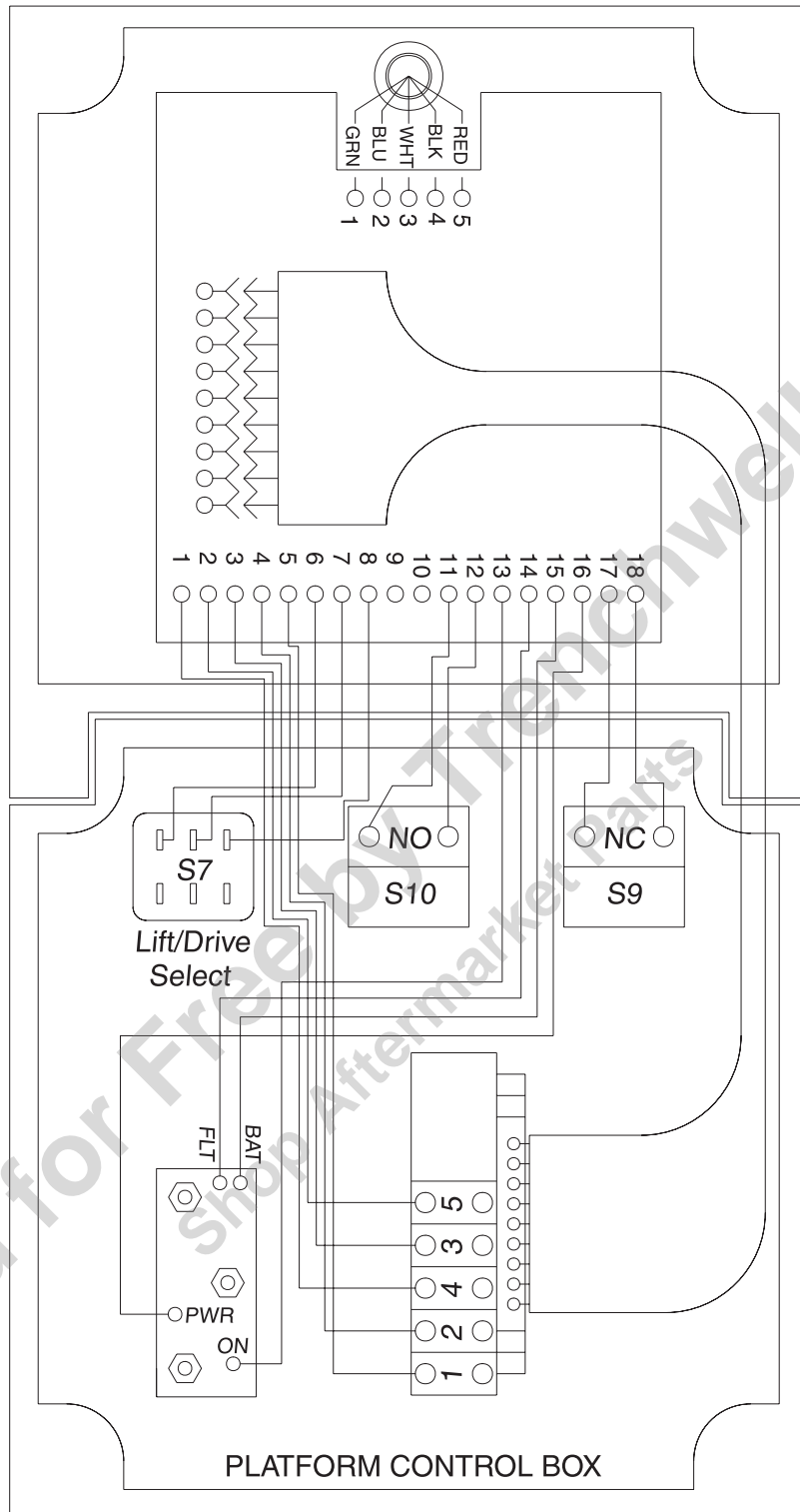

### Platform Controls Legend (models after serial number 17407)

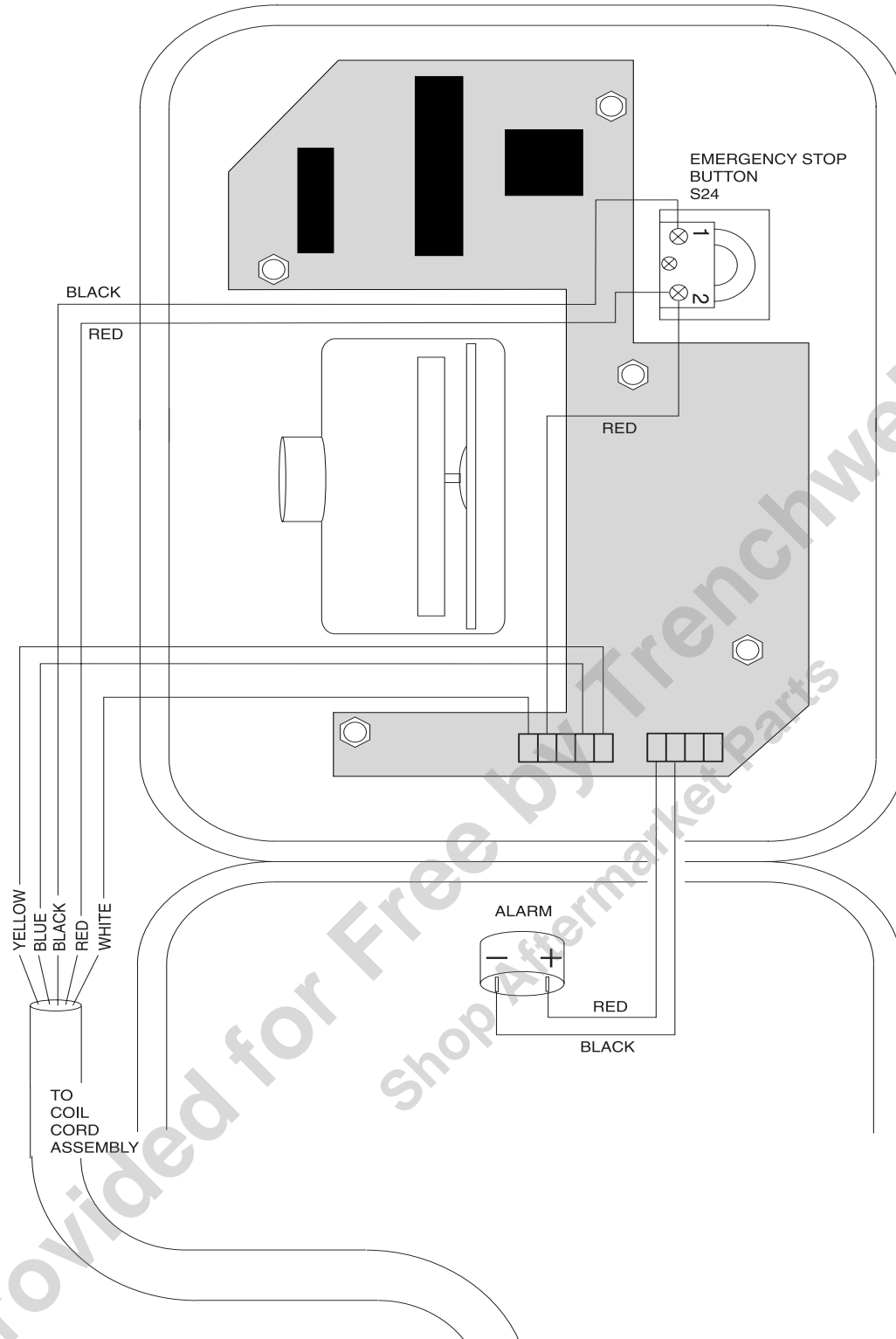

# Hydraulic Symbols Legend

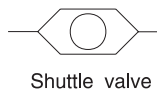
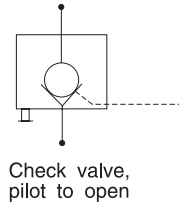
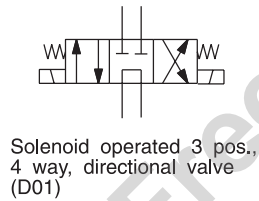
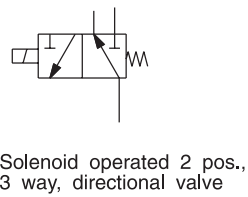
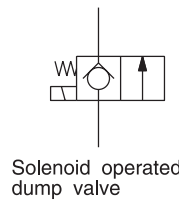
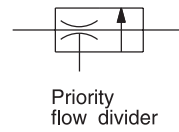
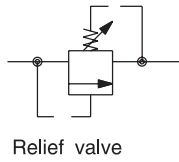
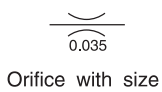
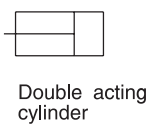
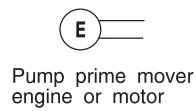
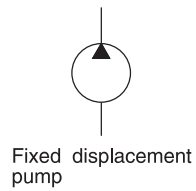
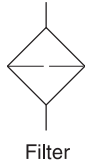

Hydraulic Schematic

N M L K J I H G F E D C B A

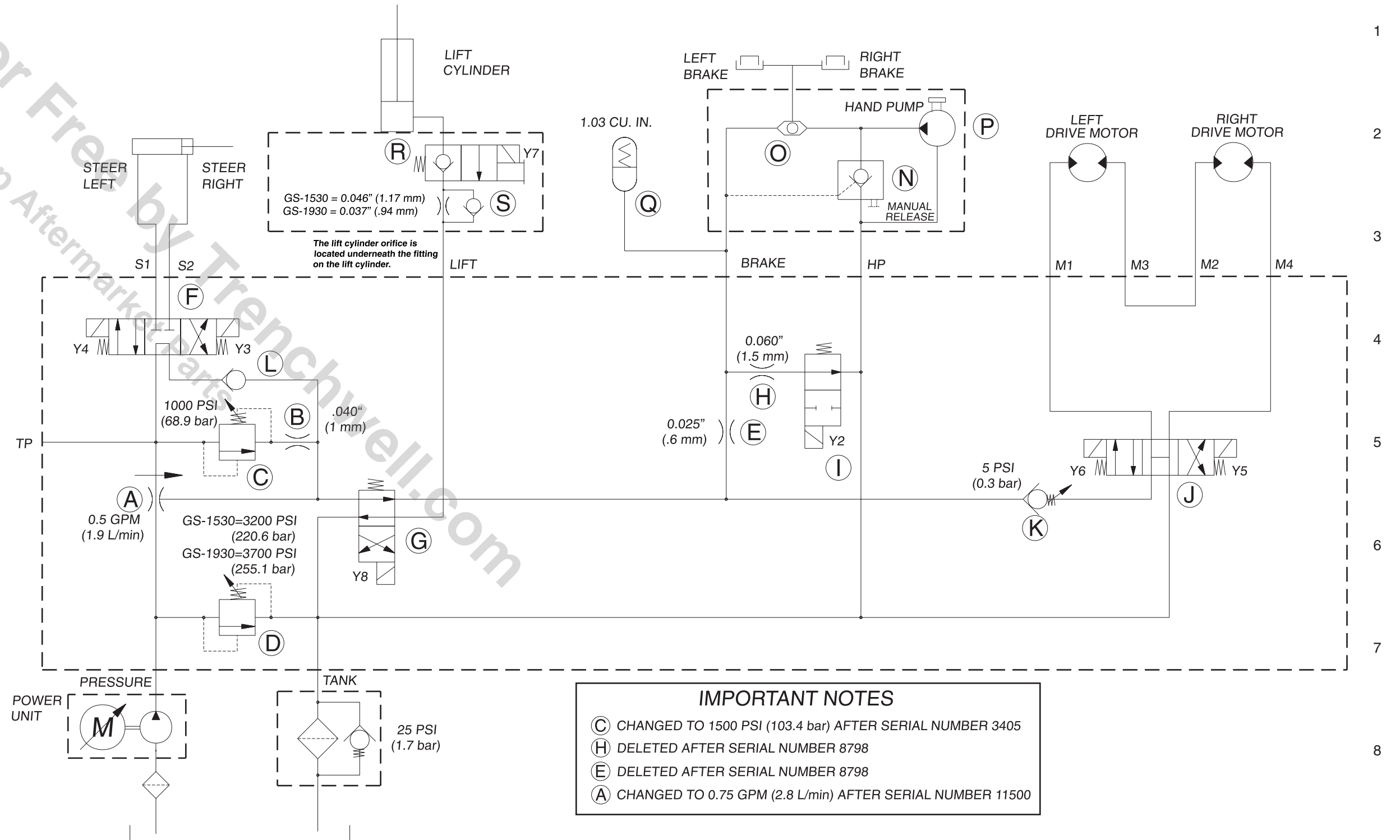

---

**Hydraulic Schematic**

Provided for Free by Trenchwell.com  
Shop Aftermarket Parts

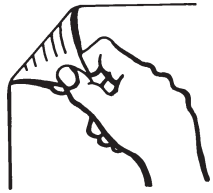

# Repair Procedures



## Observe and Obey:

- ☑ Repair procedures shall be completed by a person trained and qualified on the repair of this machine.
- ☑ Immediately tag and remove from service a damaged or malfunctioning machine.
- ☑ Repair any machine damage or malfunction before operating the machine.

## Before Repairs Start:

- ☑ Read, understand and obey the safety rules and operating instructions in the *Genie GS-1530 & Genie GS-1930 Operator's Manual*.
- ☑ Be sure that all necessary tools and parts are available and ready for use.
- ☑ Read each procedure completely and adhere to the instructions. Attempting shortcuts may produce hazardous conditions.
- ☑ Unless otherwise specified, perform each repair procedure with the machine in the following configuration:
  - Machine parked on a flat level surface
  - Platform in the stowed position
  - Key switch in the OFF position with the key removed
  - Wheels chocked

## About This Section

Most of the procedures in this section should only be performed by a trained service professional in a suitably equipped workshop. Select the appropriate repair procedure after troubleshooting the problem.

Perform disassembly procedures to the point where repairs can be completed. Then to re-assemble, perform the disassembly steps in reverse order.

## Symbols Legend



Safety alert symbol—used to alert personnel to potential personal injury hazards. Obey all safety messages that follow this symbol to avoid possible injury or death.



Red—used to indicate the presence of an imminently hazardous situation which, if not avoided, will result in death or serious injury.



Orange—used to indicate the presence of a potentially hazardous situation which, if not avoided, could result in death or serious injury.



Yellow with safety alert symbol—used to indicate the presence of a potentially hazardous situation which, if not avoided, may cause minor or moderate injury.



Yellow without safety alert symbol—used to indicate the presence of a potentially hazardous situation which, if not avoided, may result in property damage.



Green—used to indicate operation or maintenance information.

- ⦿ Indicates that a specific result is expected after performing a series of steps.

# Platform Controls

## 1-1

### Platform Controller

The platform controller is controlled by an ECM (Electronic Control Module) located in the battery pack module tray. It is a fully self-contained unit which is capable of recognizing machine malfunctions with on-board diagnostics and displays a fault code on a digital display on the ECM. This aids in troubleshooting the machine by pinpointing the fault or malfunction. See the Troubleshooting section of this manual for a list of fault codes and additional information. The ECM is not user-serviceable. For further information or assistance, consult the Genie Industries Service Department.

#### Platform Controller (before serial number 17408)

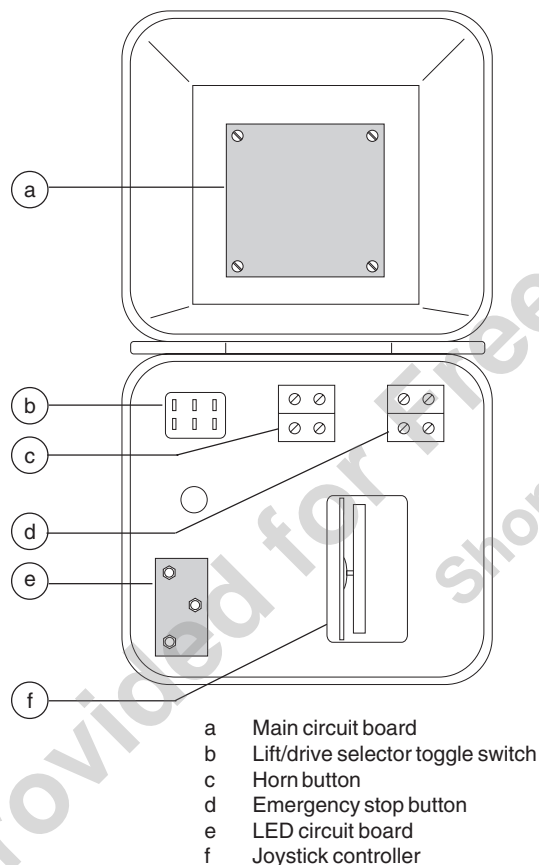

#### Platform Controller (after serial number 17407)

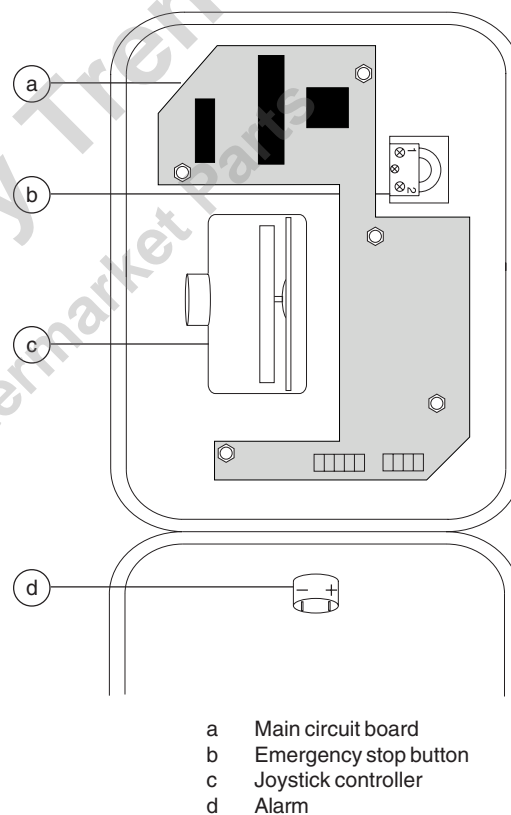

## PLATFORM CONTROLS

## 1-2 Software Configuration

The ECM (Electronic Control Module) contains programming for all configurations of the GS-1530 and GS-1930. The platform controls can be adjusted to a different configuration by changing the combination of the DIP switch settings. The DIP switch is located on the circuit board inside the platform control box.

DIP switches have two positions - ON or OFF. When reading the DIP switch code in the *DIP Switch Code Chart*, the ON and OFF are represented by the numbers 1 (ON) and 0 (OFF).

**NOTICE** Select a test area that is firm, level and free of obstructions.

**NOTICE** Models before serial number 17408 were not adjustable when they were shipped from the factory. If the ECM (Electronic Control Module) has been updated to revision "b0" or later, or if the model's serial number is after 17407, you can access the revision level of the ECM by using the following procedure:

## How to Determine the Revision Level

- 1 Remove the platform controls from the platform.
- 2 Turn the key switch to platform control and pull out the Emergency Stop buttons to the ON position at both the ground and platform controls.
- 3 Press and hold the lift enable button and the function enable switch. Move the joystick handle to the UP position to raise the platform. Observe the code shown in the LED display window, located on the battery pack side of the machine.
  - ⦿ Result: The configuration code of the DIP switch will appear in the LED display window.
- 4 Press and hold the lift enable button and the function enable switch. Move the joystick handle to the DOWN position to lower the platform. Observe the code shown in the LED display window, located on the battery pack side of the machine.
  - ⦿ Result: The software revision level will appear in the LED display window. If revision level "b0" appears in the display window, the procedure under *How to Set the DIP Switch Codes* on the next page will apply. If revision level "A" is displayed, the procedure will not apply.
- 5 Push in the Emergency Stop button to the OFF position at both the ground and platform controls and turn the key switch to the OFF position.

## PLATFORM CONTROLS

**How to Set the DIP Switch Codes**

**⚠ DANGER** Tip-over hazard. Do not adjust the DIP switch settings to other than what is specified in this procedure. Exceeding specifications will cause death or serious injury.

**NOTICE** If replacing the circuit board, note the toggle positions on the DIP switch. Set the DIP switch on the new circuit board to the same configuration of the old one.

- 1 Push in the Emergency Stop button to the OFF position at the ground and platform controls. Turn the key switch to the OFF position.
- 2 Remove the fasteners securing the top of the controller to the controller case.
- 3 Rotate the platform controller box in the position shown to correctly identify the configuration of the DIP switch settings.

- 4 Open the controller box lid and locate the DIP switch on the circuit board. Move the DIP switch settings to correspond with the configuration of the machine options, indicated in the *DIP Switch Code Chart*.

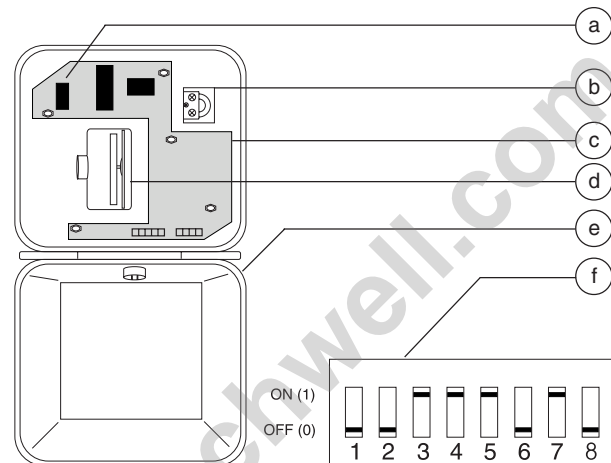

- a DIP switch
- b Emergency stop button
- c Circuit boards
- d Joystick controller
- e Controller box
- f Enlarged view of DIP switch

- 5 Close the lid and install the fasteners.
- 6 Confirm the settings. See 1-2, *How to Determine the Revision Level*.
- 7 Push in the Emergency Stop button to the OFF position at both the ground and platform controls and turn the key switch to the OFF position.

**NOTICE** Any change in DIP settings will not take effect until the key switch is turned to the OFF position.

## PLATFORM CONTROLS

**DIP Switch Code Chart**

A mark in the column indicates that the machine configuration includes this option.

Diagnostic Display Code	Dip Switch Code	Motion Beacon	Motion Alarm	Lift Drive Cut Out	Overload Cutout	Descent Delay
00	00000000					
01	00000100					•
02	00001000				•	
03	00010000			•		
04	00100000		•			
05	01000000	•				
06	00001100				•	•
07	00010100			•		•
08	00100100		•			•
09	01000100	•				•
10	00011100			•	•	•
11	00101100		•		•	•
12	01001100	•			•	•
13	00110100		•	•		•
14	01010100	•		•		•
15	01100100	•	•			•
16	00111100		•	•	•	•
17	01011100	•		•	•	•
18	01101100	•	•		•	•
19	01110100	•	•	•		•
20	01111100	•	•	•	•	•
21	00011000			•	•	
22	00101000		•		•	
23	01001000	•			•	
24	00111000		•	•	•	
25	01011000	•		•	•	
26	01101000	•	•		•	
27	01111000	•	•	•	•	
28	00110000		•	•		
29	01010000	•		•		
30	01110000	•	•	•		
31	01100000	•	•			

**DIP Switch Function Definitions**

**Motion Beacon:** The motion beacon option flashes only when operating a function.

**Motion Alarm:** The motion alarm will beep when operating any function.

**Lift/Drive Cut Out:** This cuts out lift and drive functions when the machine goes out of level. Required for Europe and Australia.

**Overload:** This cuts out lift when the cylinder is overloaded. Required for France.

**Descent Delay:** This option halts descent for 4 seconds at approximately 6 feet (2 m). Required for Europe.

PLATFORM CONTROLS

### 1-3 Toggle Switches

Toggle switches used for single function switching are single pole double throw (SPDT) switches. Dual function switching requires a double pole double throw (DPDT) switch.

#### How to Test a Toggle Switch

**NOTICE** Continuity is the equivalent of 0 to 3 ohms. A simple continuity tester may not accurately test the switch.

This procedure covers fundamental switch testing and does not specifically apply to all varieties of toggle switches.

- 1 Turn the key switch to the OFF position. Tag and disconnect all wiring from the toggle switch to be tested.

**NOTICE** The toggle switch at the platform controls requires that the wires are unplugged from the main circuit board before testing.

- 2 Connect the leads of an ohmmeter to the switch terminals in the following combinations listed below to check for continuity.

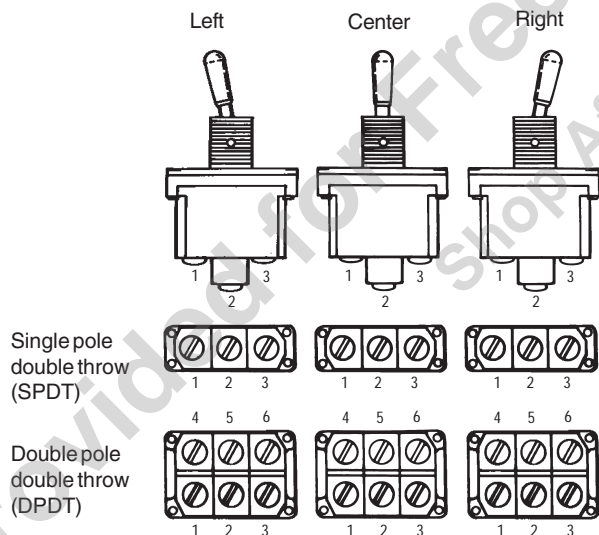

Test	Desired result
<b>Left position</b>	
terminal 1 to 2, 3, 4, 5 & 6	no continuity (infinite <b>W</b> )
terminal 2 to 3	continuity (zero <b>W</b> )
terminal 2 to 4, 5 & 6	no continuity
terminal 3 to 4, 5 & 6	no continuity
terminal 4 to 5 & 6	no continuity
terminal 5 to 6	continuity
<b>Center position</b>	
	There are no terminal combinations that will produce continuity (infinite <b>W</b> )
<b>Right position</b>	
terminal 1 to 2	continuity (zero $\Omega$ )
terminal 1 to 3, 4, 5 & 6	no continuity (infinite $\Omega$ )
terminal 2 to 3, 4, 5 & 6	no continuity
terminal 3 to 4, 5 & 6	no continuity
terminal 4 to 5	continuity
terminal 4 to 6	no continuity
terminal 5 to 6	no continuity

Provided for Free by Trenchwell.com  
Shop Aftermarket Parts

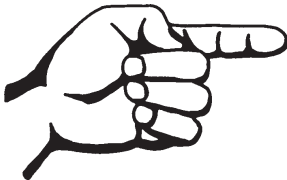

This page intentionally left blank.

# Platform Components

## 2-1 Platform

### How to Remove the Platform

**NOTICE** Perform this procedure with the platform extension fully retracted and locked in position.

- 1 Lower the platform to the stowed position.
- 2 Remove the retaining fastener that holds the platform controls quick disconnect plug to the bottom of the platform.
- 3 Twist to disconnect the plug from the platform controls.
- 4 Remove the cover to the 110V AC outlet. Label and disconnect the wiring from the outlet.

**WARNING** Electrocutation hazard. Contact with electrically charged circuits may result in death or serious injury. Remove all rings, watches and other jewelry.

- 5 Pull the wiring through the platform tube.

**NOTICE** If your machine is equipped with an air line to platform option, the air line must be disconnected from the platform before removal.

- 6 Support the platform with a forklift at the non-steer end. Do not lift it.
- 7 Attach a strap from the platform railings to the carriage on the forklift to help support the platform.
- 8 Remove the retaining fasteners from the scissor platform pivot pins at the steer end of the machine.
- 9 Use a slide hammer to remove the pins.

**WARNING** Crushing hazard. The platform will fall if it is not properly supported.

- 10 Remove the plugs from the access holes in the side of the platform.

- 11 Lift the steer end of the platform slightly to clear the scissor arms and slide the platform towards the non-steer end of the machine until the non-steer end platform pivot pins are visible through the access holes in the side of the platform.

- 12 Remove the retaining fasteners from the scissor platform pivot pins at the non-steer end of the machine.

- 13 Use a slide hammer to remove the pins.

**WARNING** Crushing hazard. The platform will fall if it is not properly supported.

- 14 Carefully lift the platform off of the machine and place it on a structure capable of supporting it.

**NOTICE** Note the position of the wear pads before the platform is removed so when the platform is installed they will be in the correct position.

## PLATFORM COMPONENTS

**2-2****Platform Extension**

---

**How to Remove the Platform Extension**

- 1 Lower the platform to the stowed position.
- 2 Extend the platform approximately 3 feet (1 m).
- 3 Remove the platform controls from the platform and lay them off to the side of the machine.
- 4 Support the platform extension with a forklift at the steer end. Do not lift it.
- 5 Attach a strap from the platform extension railings to the carriage on the forklift to help support the platform extension.
- 6 Remove the mounting fasteners from all four of the platform extension roller supports.
- 7 Remove the roller supports and the roller wheels.
- 8 Carefully slide the platform extension out from the platform and place it on a structure capable of supporting it.

**How to Replace the Platform Extension Wear Pads**

- 1 Remove the Platform Extension. See 2-2, *How to Remove the Platform Extension*.
- 2 Drill out the rivets which hold the wear pads in place.
- 3 Install the new wear pad using new rivets.

**NOTICE**

When installing new rivets, make sure the rivet heads are not above the surface of the wear pad.

# Scissor Components (before serial number 632)

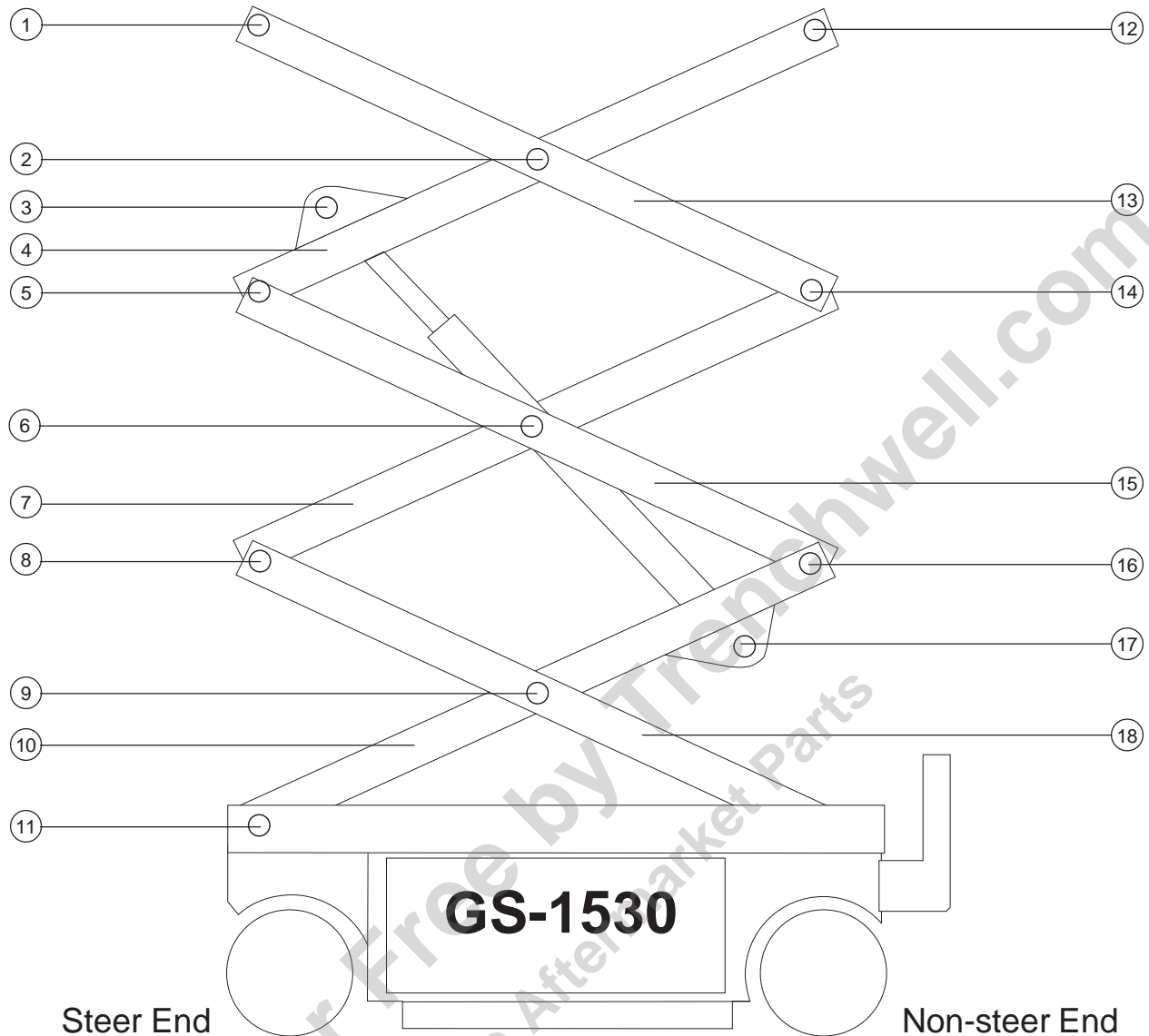

- 1 Number 4 pivot pin (steer-end)
- 2 Number 3 center pivot pin
- 3 Lift cylinder rod end pivot pin
- 4 Number 3 inner arm
- 5 Number 3 pivot pin (steer-end)
- 6 Number 2 center pivot pin
- 7 Number 2 inner arm
- 8 Number 2 pivot pin (steer-end)
- 9 Number 1 center pivot pin

- 10 Number 1 inner arm
- 11 Number 1 pivot pin (steer-end)
- 12 Number 4 pivot pin (non-steer end)
- 13 Number 3 outer arm
- 14 Number 3 pivot pin (non-steer end)
- 15 Number 2 outer arm
- 16 Number 2 pivot pin (non-steer end)
- 17 Lift cylinder barrel end pivot pin
- 18 Number 1 outer arm

## SCISSOR COMPONENTS

### 3-1 Scissor Assembly, GS-1530 Models (before serial number 632)

#### How to Disassemble the Scissor Assembly GS-1530 Models (before serial number 632)

**▲WARNING** The procedures in this section require specific repair skills, lifting equipment and a suitable workshop. Attempting this procedure without these skills and tools may result in death or serious injury and significant component damage. Dealer service is required.

Follow the disassembly steps to the point required to complete the repair. Then re-assemble the scissor assembly by following the disassembly steps in reverse order.

- 1 Remove the platform. See 2-1, *How to Remove the Platform*.
- 2 Remove the cables from the side of the number 3 outer arm (index #13) at the ground controls side.

**▲CAUTION** Component damage hazard. Cables can be damaged if they are kinked or pinched.

- 3 Attach a lifting strap from an overhead crane to the number 3 outer arm (index #13).
- 4 Remove the pin retaining fasteners from the number 3 center pivot pin (index #2) at the ground controls side.

- 5 Remove the pin retaining fasteners from the number 3 pivot pin (index #14) at the ground controls side.
- 6 Remove the external snap rings. Use a slide hammer to remove the pins.
- 7 Repeat steps 4 through 6 for the battery pack side of the machine.
- 8 Remove the number 3 outer arm (index #13) from the machine.

**▲CAUTION** Bodily injury hazard. The number 3 outer arm (index #12) may become unbalanced and fall if not properly supported when it is removed from the machine.

- 9 Remove the fasteners from the lower cable tray support at the steer end.
- 10 Remove the pin retaining fasteners from the number 2 center pivot pin (index #6). Do not remove the pin.
- 11 Slide the cable tray towards the battery pack side of the machine and remove it from the machine and lay it off to the side.

**▲CAUTION** Component damage hazard. Cables can be damaged if they are kinked or pinched.

- 12 Attach a lifting strap from an overhead crane to lug on the rod-end of the lift cylinder.
- 13 Remove the external snap ring from the cylinder rod-end pivot pin (index #3). Use a soft metal drift to remove the pin.

**▲CAUTION** Bodily injury hazard. The cylinder may fall if not properly supported when the pin is removed.

## SCISSOR COMPONENTS

- 14 Lower the cylinder onto the number 1 center pivot pin (index #9).
- 15 Attach a lifting strap from an overhead crane to number 3 inner arm (index #4).
- 16 Remove the pin retaining fasteners from the number 3 pivot pin (index #5). Do not remove the pin.
- 17 Remove the external snap ring. Use a slide hammer to remove the pin.
- 18 Repeat steps 16 and 17 for the battery pack side.

**CAUTION** Bodily injury hazard. The number 3 inner arm (index #4) may become unbalanced and fall if not properly supported when the pins are removed.

- 19 Attach a strap from an overhead crane to the number 2 outer arm (index #15).
- 20 Remove the pin retaining fasteners from the number 2 center pivot pin (index #6) at the ground controls side.
- 21 Remove the external snap ring. Use a slide hammer to remove the pin.
- 22 Remove the pin retaining fasteners from the number 2 pivot pin (index #16) at the ground controls side.
- 23 Remove the external snap ring. Use a slide hammer to remove the pin.

- 24 Repeat steps 20 through 23 for the battery pack side of the machine. Remove the arm from the machine.

**CAUTION** Bodily injury hazard. The number 2 outer arm (index #15) may become unbalanced and fall if not properly supported when the pins are removed.

- 25 Attach a lifting strap from an overhead crane to the number 2 inner arm (index #7).
- 26 Remove the pin retaining fasteners from the number 2 pivot pin (index #8).
- 27 Remove the external snap ring. Use a slide hammer to remove the pin.
- 28 Repeat steps 26 and 27 for the battery pack side of the machine. Remove the arm from the machine.

**CAUTION** Bodily injury hazard. The number 2 inner arm (index #7) may become unbalanced and fall if not properly supported when the pins are removed.

- 29 Remove the retaining fasteners on the safety arm from the number 2 inner arm (index #7) that was just removed.
- 30 Attach the strap from the crane to the number 1 inner arm (index #10).
- 31 Raise the number 1 inner arm (index #10) approximately 2 feet (0.6 m) and insert the safety arm between the number 1 inner arm (index #10) and the number 1 outer arm (index #18).

**CAUTION** Bodily injury hazard. Keep hands clear of moving parts when inserting the safety arm.

## SCISSOR COMPONENTS

32 Disconnect and plug the hydraulic hose on the lift cylinder. Cap the fitting on the cylinder.

**▲WARNING** Bodily injury hazard. Spraying hydraulic oil can penetrate and burn skin. Loosen hydraulic connections very slowly to allow the oil pressure to dissipate gradually. Do not allow oil to squirt or spray.

33 Tag and disconnect the wires from the solenoid valve on the cylinder.

34 Attach the strap from the crane to the lug on the rod end of the cylinder.

35 Remove the external snap ring from the cylinder barrel-end pin (index #17). Use a soft metal drift to remove the pin. Remove the cylinder from the machine.

**▲WARNING** Crushing hazard. If the overhead crane is not properly attached, the cylinder may become unbalanced and fall when it is removed from the machine.

**▲CAUTION** Component damage hazard. Be careful not to damage the valve or fittings on the cylinder while removing it from the machine.

36 Place a 4 x 4 x 32 inch (10 x 10 x 81 cm) long block across both sides of the chassis under the number 1 center pivot pin (index number #9).

37 Attach the strap from the crane to the number 1 inner arm (index #10). Raise the inner arm slightly and remove the safety arm. Lower the arms on to the block.

**▲CAUTION** Bodily injury hazard. Keep hands clear of moving parts when lowering the arms onto the block.

38 Remove the cables from the number 1 inner arm (index #10) and lay off to the side.

**▲CAUTION** Component damage hazard. Cables can be damaged if they are kinked or pinched.

39 Attach the overhead crane to the number 1 outer arm (index #17). Do not lift it.

40 Remove the pin retaining fasteners from the number 1 center pivot pin (index #9) at the ground controls side.

41 Remove the external snap ring. Use a slide hammer to remove the pin.

42 Repeat steps 40 and 41 for the battery pack side.

**▲CAUTION** Bodily injury hazard. The number 1 outer arm (index #17) may become unbalanced and fall if not properly supported when the pins are removed.

43 Slide the arm to the non-steer end and remove the outer base scissor arm from the machine.

**NOTICE** Note the position of the wear pads before the arm is removed so when the scissor is assembled they will be in the correct position.

## SCISSOR COMPONENTS

- 44 Attach the overhead crane to the number 1 inner arm (index #10). Do not lift it.
- 45 Remove the pin retaining fasteners from the number 1 pivot pin at the ground controls side. Use a slide hammer to remove the pin.
- 46 Repeat step 45 for the battery pack side. Remove the number 1 inner arm (index #10) from the machine.

**CAUTION** Bodily injury hazard. The number 1 inner arm (index #10) may become unbalanced and fall if not properly supported when the pins are removed.

### How to Replace the Scissor Arm Wear Pads (before serial number 632)

- 1 Remove the platform. See 2-1, *How to Remove the Platform*.
- 2 Carefully slide the forks from a forklift under the scissor arms at the non-steer end of the machine.
- 3 Attach a strap from the scissor arms to the carriage on the forklift for support.
- 4 Remove the pin retaining fasteners from the number 1 inner arm pivot pins. Use a slide hammer to remove the pins.
- 5 Remove the fasteners from the level sensor box. Remove the box.
- 6 Remove the fasteners from the level sensor. Remove the level sensor.
- 7 Slide the scissor assembly towards the non-steer end of the machine approximately 18 inches (45.7 cm).
- 8 Remove the mounting fasteners from the stationary wear pads on the platform and at the steer end of the chassis.

**NOTICE** Note the position of the old wear pads before they are removed so when the new ones are installed they will be in the correct position.

- 9 Install the new wear pads with new fasteners.
- 10 Slide the movable wear pads off of the number 3 inner arm (index #3) and the number 1 outer arm (index #16). Install the new wear pads.
- 11 Re-assemble machine in reverse order in which it was disassembled.

SCISSOR COMPONENTS

Provided for Free by Trenchwell.com  
Shop Aftermarket Parts

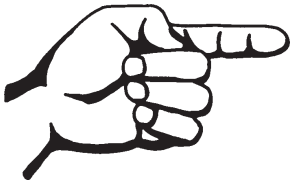

This page intentionally left blank.

## SCISSOR COMPONENTS

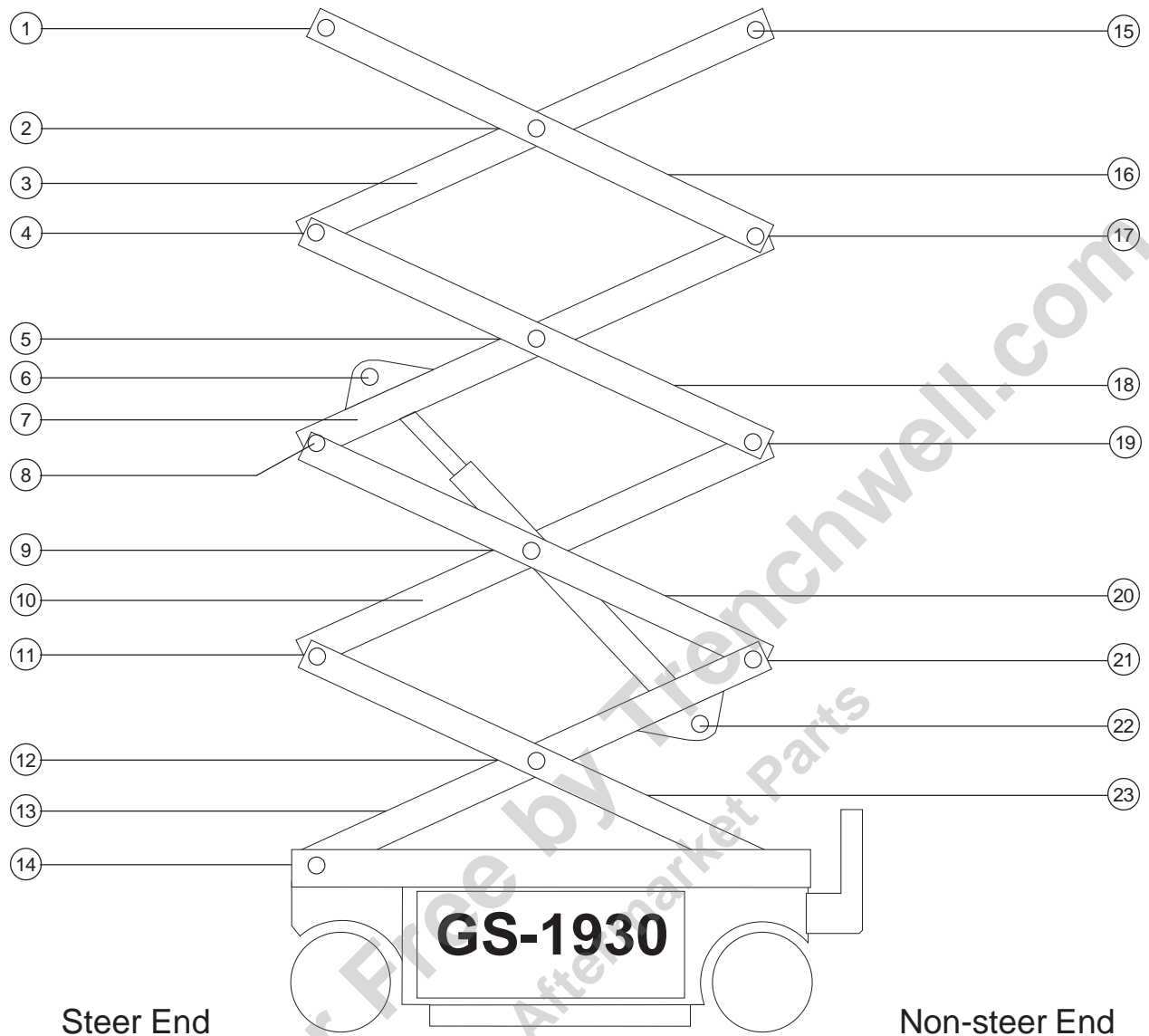

- Steer End
- 1 Number 5 pivot pin (steer-end)
  - 2 Number 4 center pivot pin
  - 3 Number 4 inner arm
  - 4 Number 4 pivot pin (steer-end)
  - 5 Number 3 center pivot pin
  - 6 Lift cylinder rod end pivot pin
  - 7 Number 3 inner arm
  - 8 Number 3 pivot pin (steer-end)
  - 9 Number 2 center pivot pin
  - 10 Number 2 inner arm
  - 11 Number 2 pivot pin (steer-end)
  - 12 Number 1 center pivot pin

- Non-steer End
- 13 Number 1 inner arm
  - 14 Number 1 pivot pin (steer-end)
  - 15 Number 5 pivot pin (non-steer end)
  - 16 Number 4 outer arm
  - 17 Number 4 pivot pin (non-steer end)
  - 18 Number 3 outer arm
  - 19 Number 3 pivot pin (non-steer end)
  - 20 Number 2 outer arm
  - 21 Number 2 pivot pin (non-steer end)
  - 22 Lift cylinder barrel end pivot pin
  - 23 Number 1 outer arm

## SCISSOR COMPONENTS

### 3-2 Scissor Assembly, GS-1930 Models (before serial number 632)

#### How to Disassemble the Scissor Assembly GS-1930 Models (before serial number 632)

**▲WARNING** The procedures in this section require specific repair skills, lifting equipment and a suitable workshop. Attempting this procedure without these skills and tools may result in death or serious injury and significant component damage. Dealer service is required.

Follow the disassembly steps to the point required to complete the repair. Then re-assemble the scissor assembly by following the disassembly steps in reverse order.

- 1 Remove the platform. See 2-1, *How to Remove the Platform*.
- 2 Remove the cables from the side of the outer platform support arm (index #16) at the ground controls side.
- 3 Remove the retaining fasteners from the center pivot pins (index #2) at both the ground controls side and the battery pack side. Do not remove the pins.
- 4 Remove the upper cable tray and lay off to the side.

**▲CAUTION** Component damage hazard. Cables can be damaged if they are kinked or pinched.

- 5 Attach a lifting strap from an over head crane to the steer-end outer platform support arm (index #16).
- 6 Remove the external snap ring from the number 4 center pivot pin (index #2) at the ground controls side. Use a slide hammer to remove the pin.
- 7 Remove the pin retaining fasteners from the number 4 pivot pin (index #17) at the non-steer end the machine at the ground controls side.
- 8 Remove the external snap ring from the number 4 pivot pin (index #17) at the ground controls side. Use a slide hammer to remove the pin.
- 9 Repeat steps 6 through 8 for the battery pack side of the machine.
- 10 Remove the arm from the machine.

**▲CAUTION** Bodily injury hazard. The number 4 outer arm (index #16) may become unbalanced and fall if not properly supported when it is removed from the machine.

- 11 Attach a lifting strap from an overhead crane to the number 4 inner arm (index #3).
- 12 Remove the pin retaining fasteners from the number 4 pivot pin (index #4) at both sides of the machine.
- 13 Remove the external snap ring from the number 4 pivot pin (index #4). Use a slide hammer to remove the pin.
- 14 Repeat steps 11 and 12 for the battery pack side of the machine.

**▲CAUTION** Bodily injury hazard. The number 4 inner arm (index #3) may become unbalanced and fall if not properly supported when it is removed.

## SCISSOR COMPONENTS

15 Attach a lifting strap from an overhead crane to the number 3 outer arm (index #18).

16 Remove the pin retaining fasteners from the number 3 center pivot pin (index #5) at the ground controls side.

17 Remove the external snap ring. Use a slide hammer to remove the pin.

**CAUTION** Bodily injury hazard. The number 3 outer arm (index #18) may become unbalanced and fall if not properly supported when the center pivot pin is removed.

18 Remove the pin retaining fasteners from the number 3 pivot pin (index #19) at the non-steer end.

19 Remove the external snap ring. Use a slide hammer to remove the pin.

**CAUTION** Bodily injury hazard. The number 3 outer arm (index #18) may become unbalanced and fall if not properly supported when it is removed.

20 Repeat steps 16 through 19 for the battery pack side of the machine.

21 Remove the fasteners from the lower cable tray support at the steer end.

22 Remove the pin retaining fasteners from the number 2 center pivot pin (index #9) at the ground controls side. Do not remove the pin.

23 Slide the cable tray towards the battery pack side of the machine and remove it from the machine and lay it off to the side.

**CAUTION** Component damage hazard. Cables can be damaged if they are kinked or pinched.

24 Attach a lifting strap from an overhead crane to lug on the rod end of the lift cylinder to support it.

25 Remove the external snap ring from the cylinder rod-end pivot pin (index #6). Use a soft metal drift to remove the pin.

**CAUTION** Bodily injury hazard. The cylinder may fall if not properly supported when the pin is removed.

26 Lower the cylinder onto the number 1 center pivot pin (index #12).

27 Attach a lifting strap from an overhead crane to the number 3 inner arm (index #7).

28 Remove the pin retaining fasteners from the number 3 pivot pin (index #8) at the steer end of the machine at the ground controls side.

29 Remove the external snap ring. Use a slide hammer to remove the pin.

**CAUTION** Bodily injury hazard. The number 3 inner arm (index #7) may fall if not properly supported when the pins are removed.

30 Repeat steps 28 and 29 for the battery pack side.

31 Attach a strap from an overhead crane to the number 2 outer arm (index #20) at the ground controls side.

32 Remove the pin retaining fasteners from the number 2 center pivot pin (index #9) at the ground controls side.

33 Remove the external snap ring. Use a slide hammer to remove the pin.

## SCISSOR COMPONENTS

34 Remove the pin retaining fasteners from the number 2 pivot pin (index #21) at the ground controls side.

35 Remove the external snap ring. Use a slide hammer to remove the pin.

36 Repeat steps 32 through 35 for the battery pack side of the machine.

**CAUTION** Bodily injury hazard. The number 2 outer arm (index #20) may become unbalanced and fall if not properly supported when the pins are removed.

37 Attach a lifting strap from an over head crane to the number 2 inner arm (index #10).

38 Remove the pin retaining fasteners from the number 2 pivot pin (index #11) at the ground controls side.

39 Remove the external snap ring. Use a slide hammer to remove the pin.

40 Repeat steps 38 and 39 for the battery pack side of the machine.

**CAUTION** Bodily injury hazard. The number 2 inner arm (index #10) may become unbalanced and fall if not properly supported when the pins are removed.

41 Remove the retaining fasteners on the safety arm from the number 2 inner arm (index #10) that was just removed.

42 Attach the strap from the crane to the number 1 inner arm (index #13).

43 Raise the number 1 inner arm (index #13) approximately 2 feet (0.6 m) and insert the safety arm between the number 1 inner arm (index #13) and the number 1 outer arm (index #23) at the steer end of the machine.

**CAUTION** Bodily injury hazard. Keep hands clear of moving parts when inserting the safety arm.

44 Disconnect and plug the hydraulic hose on the lift cylinder. Cap the fitting on the cylinder.

**WARNING** Bodily injury hazard. Spraying hydraulic oil can penetrate and burn skin. Loosen hydraulic connections very slowly to allow the oil pressure to dissipate gradually. Do not allow oil to squirt or spray.

45 Tag and disconnect the wires from the solenoid valve on the cylinder.

46 Attach the strap from the crane to the lug on the rod end of the cylinder.

47 Remove the external snap ring from the cylinder barrel-end pivot pin (index #22). Use a soft metal drift to remove the pin. Remove the cylinder from the machine.

**WARNING** Crushing hazard. If the overhead crane is not properly attached, the cylinder may become unbalanced and fall when it is removed from the machine.

**CAUTION** Component damage hazard. Be careful not to damage the valve or fittings on the cylinder while removing it from the machine.

## SCISSOR COMPONENTS

48 Place a 4 x 4 x 32 inch (10 x 10 x 81 cm) long block across both sides of the chassis under the number 1 center pivot pin (index #12).

49 Attach the strap from the crane to the number 1 inner arm (index #13) at the non-steer end. Raise the arm slightly and remove the safety arm. Lower the arm on to the block.

**CAUTION** Bodily injury hazard. Keep hands clear of moving parts when lowering the arms onto the block.

50 Remove the cables from the number 1 inner arm (index #13) and lay off to the side.

**CAUTION** Component damage hazard. Cables can be damaged if they are kinked or pinched.

51 Attach the overhead crane to the number 1 outer arm (index #23). Do not lift it.

52 Remove the pin retaining fasteners from the number 1 center pivot pin (index #1) at the ground controls side.

53 Remove the external snap ring. Use a slide hammer to remove the pin.

54 Repeat steps 52 and 53 for the battery pack side.

**CAUTION** Bodily injury hazard. The number 1 outer arm (index #23) may become unbalanced and fall if not properly supported when the pins are removed.

55 Slide the arm to the non-steer end and remove the number 1 outer arm (index #23) from the machine.

**NOTICE** Note the position of the wear pads before the arm is removed so when the scissor is assembled they will be in the correct position.

56 Attach the overhead crane to the number 1 inner arm (index #13). Do not lift it.

57 Remove the pin retaining fasteners from the number 1 pivot pin (index #14) at the ground controls side. Use a slide hammer to remove the pin.

58 Repeat step 57 for the battery pack side. Remove the number 1 inner arm (index #13) from the machine.

**CAUTION** Bodily injury hazard. The number 1 inner arm (index #13) may become unbalanced and fall if not properly supported when the pins are removed.

## SCISSOR COMPONENTS

## How to Replace the Scissor Arm Wear Pads (before serial number 632)

- 1 Remove the platform. See 2-1, *How to Remove the Platform*.
- 2 Carefully slide the forks from a forklift under the scissor arms at the non-steer end of the machine.
- 3 Attach a strap from the scissor arms to the carriage on the forklift for support.
- 4 Remove the pin retaining fasteners from the number 1 inner arm pivot pins. Use a slide hammer to remove the pins.
- 5 Remove the fasteners from the level sensor box. Remove the box.
- 6 Remove the fasteners from the level sensor. Remove the level sensor.
- 7 Slide the scissor assembly towards the non-steer end of the machine approximately 18 inches (45.7 cm).
- 8 Remove the mounting fasteners from the stationary wear pads on the platform and at the steer end of the chassis.

**NOTICE**

Note the position of the old wear pads before they are removed so when the new ones are installed they will be in the correct position.

- 9 Install the new wear pads with new fasteners.
- 10 Slide the movable wear pads off of the number 4 inner arm (index #3) and the number 1 outer arm (index #21). Install the new wear pads.
- 11 Re-assemble machine in reverse order in which it was disassembled.

# Scissor Components (after serial number 631)

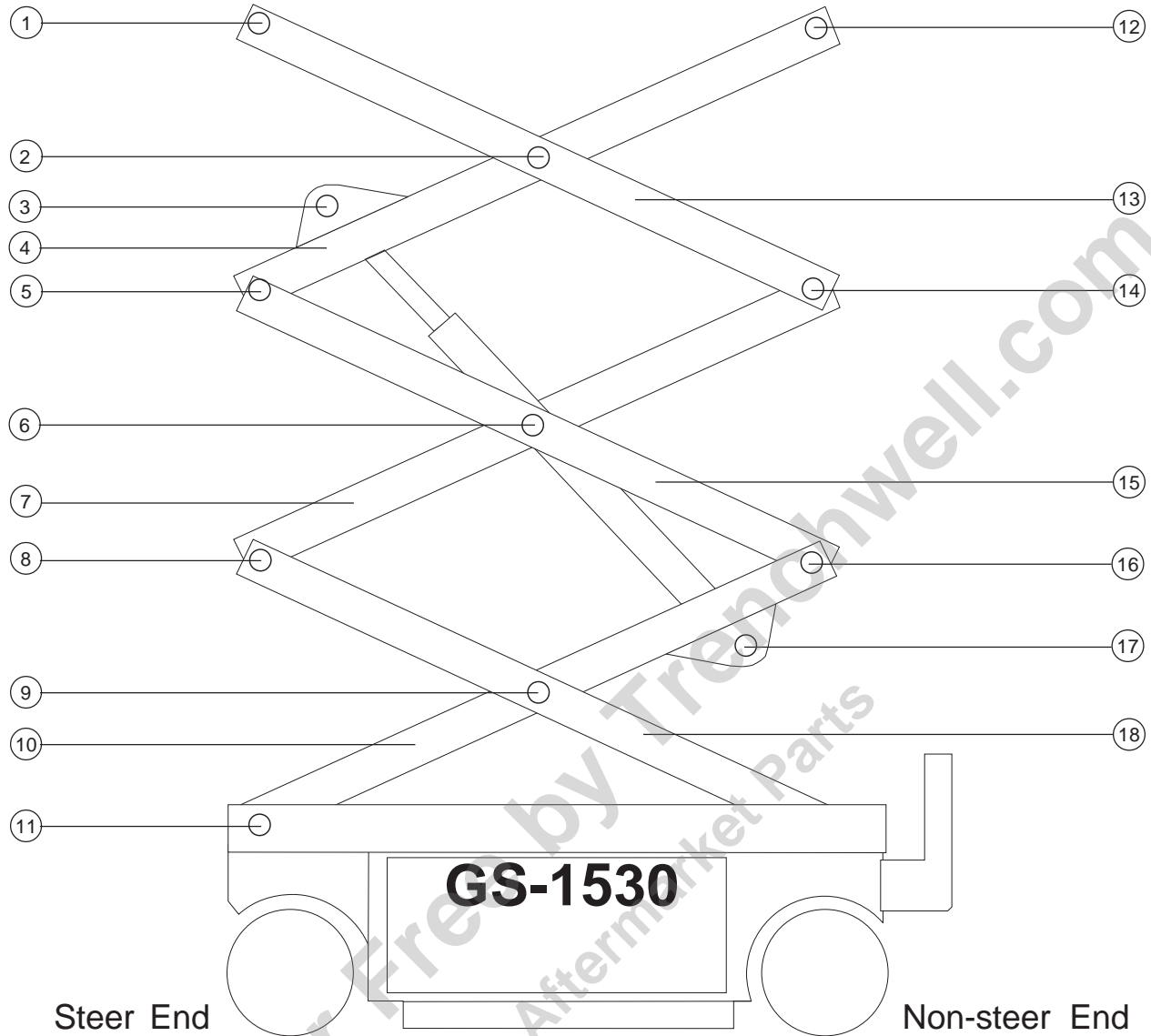

- 1 Number 4 pivot pin (steer-end)
- 2 Number 3 center pivot pin
- 3 Lift cylinder rod-end pin
- 4 Number 3 inner arm
- 5 Number 3 pivot pin (steer-end)
- 6 Number 2 center pivot pin (2 pins)
- 7 Number 2 inner arm
- 8 Number 2 pivot pin (steer-end)
- 9 Number 1 center pivot pin

- 10 Number 1 inner arm
- 11 Number 1 pivot pin (steer-end)
- 12 Number 4 pivot pin (non-steer end)
- 13 Number 3 outer arm
- 14 Number 3 pivot pin (non-steer end)
- 15 Number 2 outer arm
- 16 Number 2 pivot pin (non-steer end)
- 17 Lift cylinder barrel-end pin
- 18 Number 1 outer arm

## SCISSOR COMPONENTS

### 3-3 Scissor Assembly, GS-1530 Models (after serial number 631)

#### How to Disassemble the Scissor Assembly GS-1530 Models (after serial number 631)

**▲WARNING** This procedure requires specific repair skills, lifting equipment and a suitable workshop. Attempting this procedure without these skills and tools may result in death or serious injury and significant component damage. Dealer service is required.

**NOTICE** When removing a hose assembly or fitting, the O-ring on the fitting and/or hose end must be replaced and then torqued to specification during installation. Refer to Section Two, *Hydraulic Hose and Fitting Torque Specifications*.

- 1 Remove the platform. See 2-1, *How to Remove the Platform*.
- 2 Remove the cables from the side of the number 3 outer arm (index #13) at the ground controls side.

**▲CAUTION** Component damage hazard. Cables can be damaged if they are kinked or pinched.

- 3 Attach a lifting strap from an overhead crane to the number 3 outer arm (index #13).
- 4 Remove the external snap rings from the number 3 center pivot pin (index #2).

- 5 Use a soft metal drift to remove the number 3 center pivot pin (index #2).
- 6 Remove the external snap rings from the number 3 pivot pin (index #14).
- 7 Use a soft metal drift to remove the number 3 pivot pin (index #14). Remove the number 3 outer arm (index #13) from the machine.

**▲CAUTION** Bodily injury hazard. The number 3 outer arm (index #13) may become unbalanced and fall if not properly supported when it is removed from the machine.

- 8 Remove the cable clamps from the number 3 inner arm (index #4).
- 9 Remove the mounting fasteners from the cable tray support at the steer end.
- 10 Remove the external snap rings from the number 2 center pivot pin (index #6) at the ground controls side. Do not remove the pin.
- 11 Slide the cable tray towards the battery pack side of the machine and remove it from the machine and lay it off to the side.

**▲CAUTION** Component damage hazard. Cables can be damaged if they are kinked or pinched.

- 12 Attach a lifting strap from an overhead crane to lug on the rod end of the lift cylinder.
- 13 Remove the pin retaining fasteners from the cylinder rod-end pivot pin (index #3). Use a soft metal drift to remove the pin.

**▲CAUTION** Bodily injury hazard. The cylinder may fall if not properly supported when the pin is removed.

## SCISSOR COMPONENTS

- 14 Lower the cylinder onto the number 1 center pivot pin (index #9).
- 15 Attach a lifting strap from an overhead crane to number 3 inner arm (index #4).
- 16 Remove the external snap rings from the number 3 pivot pin (index #5).
- 17 Use a soft metal drift to remove the number 3 pivot pin (index #5). Remove the number 3 inner arm (index #4) from the machine.

**CAUTION** Bodily injury hazard. The number 3 inner arm (index #4) may become unbalanced and fall if not properly supported when it is removed from the machine.

- 18 Attach a lifting strap from an overhead crane to the number 2 outer arm (index #15).
- 19 Remove the external snap rings from the number 2 center pivot pin (index #6) at the battery pack side.
- 20 Use a soft metal drift to remove both of the number 2 center pivot pins (index #6).
- 21 Remove the external snap rings from the number 2 pivot pin (index #16).
- 22 Use a soft metal drift to remove the number 2 pivot pin (index #16). Remove the number 2 outer arm (index #15) from the machine.

**CAUTION** Bodily injury hazard. The number 2 outer arm (index #15) may become unbalanced and fall if not properly supported when it is removed from the machine.

- 23 Attach a lifting strap from an overhead crane to the number 2 inner arm (index #7).
- 24 Remove the external snap rings from the number 2 pivot pin (index #8).
- 25 Use a soft metal drift to remove the number 2 pivot pin (index #8). Remove the number 2 inner arm (index #7) from the machine.

**CAUTION** Bodily injury hazard. The number 2 inner arm (index #7) may become unbalanced and fall if not properly supported when it is removed from the machine.

- 26 Remove the safety arm from the number 2 inner arm (index #7) that was just removed.
- 27 Attach the strap from the overhead crane to the number 1 inner arm (index #10).
- 28 Raise the number 1 inner arm (index #10) approximately 2 feet (0.6 m) and insert the safety arm between the number 1 inner arm (index #10) and the number 1 outer arm (index #18).

**CAUTION** Bodily injury hazard. Keep hands clear of moving parts when inserting the safety arm.

- 29 Disconnect and plug the hydraulic hose on the lift cylinder. Cap the fitting on the cylinder.

**WARNING** Bodily injury hazard. Spraying hydraulic oil can penetrate and burn skin. Loosen hydraulic connections very slowly to allow the oil pressure to dissipate gradually. Do not allow oil to squirt or spray.

## SCISSOR COMPONENTS

30 Tag and disconnect the wires from the solenoid valve on the cylinder.

31 Attach the strap from an overhead crane to the lug on the rod end of the lift cylinder.

32 Remove the pin retaining fasteners from the cylinder barrel-end pivot pin (index #17). Use a soft metal drift to remove the pin. Remove the cylinder from the machine.

**AWARNING** Crushing hazard. If the overhead crane is not properly attached, the cylinder may become unbalanced and fall when it is removed from the machine.

**CAUTION** Component damage hazard. Be careful not to damage the valve or fittings on the cylinder while removing it from the machine.

33 Place a 4 x 4 x 32 (10 x 10 x 81 cm) inch long block across both sides of the chassis under the number 1 center pivot pin (index #9).

34 Attach the strap from the overhead crane to the number 1 inner arm (index #10). Raise the inner arm slightly and remove the safety arm. Lower the arms on to the block.

**CAUTION** Bodily injury hazard. Keep hands clear of moving parts when lowering the arms onto the block.

35 Remove the cables from the number 1 inner arm (index #10) and lay off to the side.

**CAUTION** Component damage hazard. Cables can be damaged if they are kinked or pinched.

36 Attach the strap from the overhead crane to the number 1 outer arm (index #18). Do not lift it.

37 Remove the external snap rings from the number 1 center pivot pin (index #9).

38 Use a soft metal drift to remove the number 1 center pivot pin (index #9).

**CAUTION** Bodily injury hazard. The number 1 outer arm (index #18) may become unbalanced and fall if not properly supported when the pin is removed.

39 Slide the number 1 outer arm (index #18) to the non-steer end and remove it from the machine.

**CAUTION** Bodily injury hazard. The number 1 outer arm (index #18) may become unbalanced and fall if not properly supported when removing it from the machine.

**NOTICE** Note the position of the wear pads before the arm is removed so when the scissor is assembled they will be in the correct position.

40 Attach the strap from an overhead crane to the number 1 inner arm (index #10). Do not lift it.

41 Remove the pin retaining fasteners from both of the number 1 pivot pins (index #10) at the steer end of the machine. Use a slide hammer to remove the pins.

42 Remove the number 1 inner arm (index #10) from the machine.

**CAUTION** Bodily injury hazard. The number 1 inner arm (index #10) may become unbalanced and fall if not properly supported when removed from the machine.

## SCISSOR COMPONENTS

## How to Replace the Scissor Arm Wear Pads (after serial number 631)

- 1 Remove the platform. See 2-1, *How to Remove the Platform*.
- 2 Remove the mounting fasteners from the stationary wear pads on the platform.

**NOTICE** Note the position of the old wear pads before they are removed so when the new ones are installed they will be in the correct position.

- 3 Remove the fasteners from the entry ladder and remove the entry ladder.
- 4 Raise the platform approximately 7 to 8 feet (2.1 to 2.4 m).
- 5 Rotate the safety arm away from the machine.
- 6 Lower the platform onto the safety arm.
- 7 Mark the mounting position of the level sensor box on the drive chassis.
- 8 Remove the level sensor box lid.
- 9 Mark the mounting position of the level sensor on the level sensor box.
- 10 Remove the mounting fasteners from the level sensor.

- 11 Remove the fasteners from the level sensor box and slide it towards the non-steer end of the machine as far as it will go.

**CAUTION** Component damage hazard. Be careful not to damage the level sensor box, limit switch, level sensor or wiring while moving the level sensor box.

- 12 Secure the ends of the scissor arms together at both ends of the machine with a tie down strap or other appropriate device.
- 13 Remove the pin retaining fasteners from the number 1 inner arm pivot pins at the steer end of the machine. Use a slide hammer to remove the pins.
- 14 Attach a strap from an overhead crane to the steer end of the scissor arms.
- 15 Carefully slide the forks from a forklift under the scissor arms at the non-steer end of the machine.
- 16 Raise the scissor arms up until the number 1 inner arm will clear the level sensor box.

**CAUTION** Component damage hazard. Be careful not to damage the level sensor box, limit switch or level sensor while moving the scissor assembly.

- 17 Move the scissor assembly towards the non-steer end of the machine slightly and to one side of the machine until one of the scissor arm wear pads are accessible. Do not allow both wear pads to slide out of the drive chassis.

**DANGER** The scissor assembly will fall if both wear pads are allowed to slide out of the drive chassis.

18 Install the new wear pad.

**NOTICE** Note the position of the old wear pad before it is removed so when the new one is installed it will be in the correct position.

19 Move the scissor assembly towards the other side of the machine until the other scissor arm wear pad is accessible.

**⚠ DANGER** The scissor assembly will fall if both wear pads are allowed to slide out of the drive chassis.

20 Install the new wear pad.

**NOTICE** Note the position of the old wear pad before it is removed so when the new one is installed it will be in the correct position.

21 Slide the scissor assembly back into the drive chassis.

22 Lower the scissor assembly into position and install the pivot pins.

**⚠ CAUTION** Component damage hazard. Be careful not to damage the level sensor box, limit switch or level sensor while installing the scissor assembly.

## SCISSOR COMPONENTS

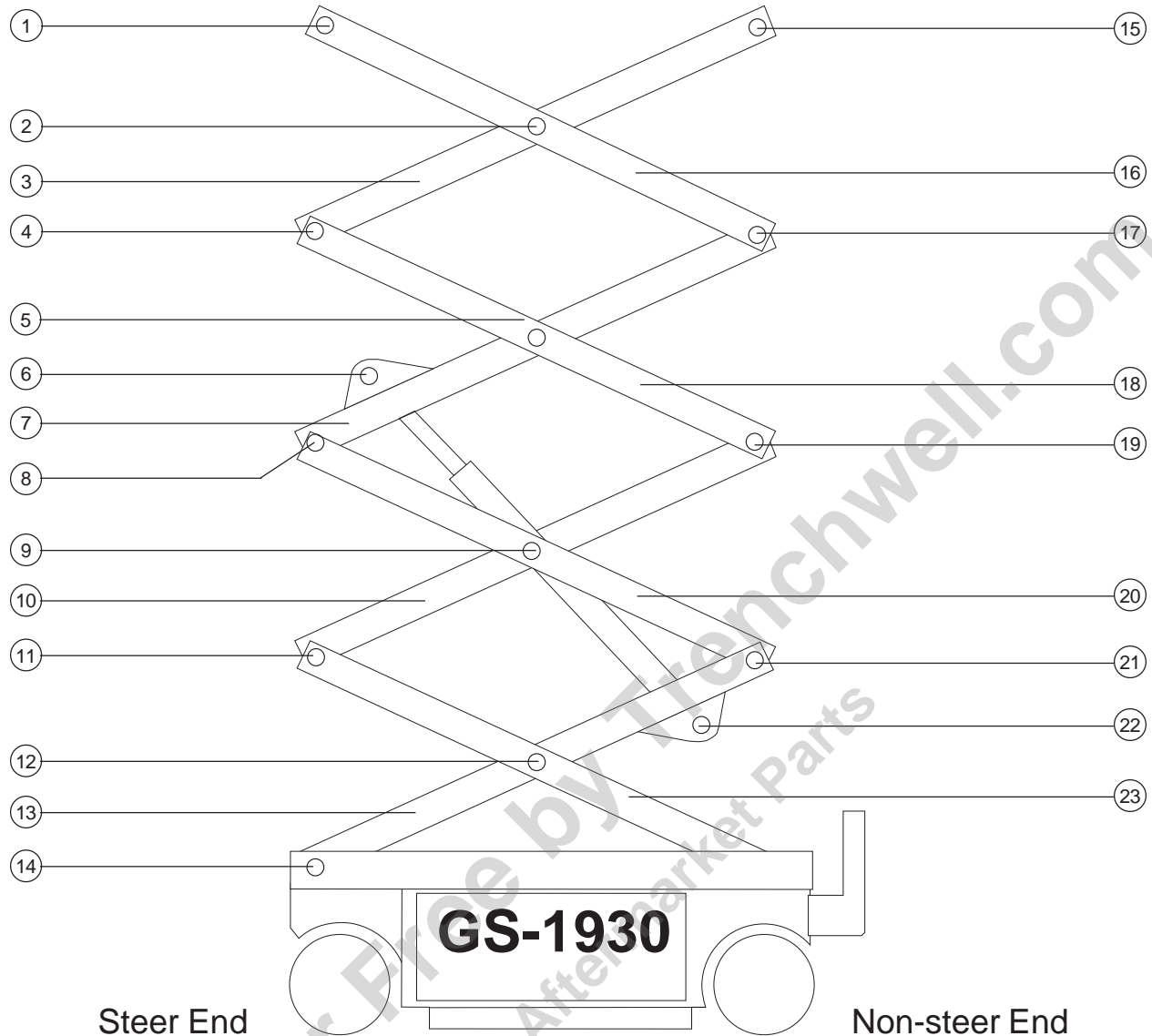

- 1 Number 5 pivot pin (steer-end)
- 2 Number 4 center pivot pin
- 3 Number 4 inner arm
- 4 Number 4 pivot pin (steer-end)
- 5 Number 3 center pivot pin
- 6 Lift cylinder rod-end pin
- 7 Number 3 inner arm
- 8 Number 3 pivot pin (steer-end)
- 9 Number 2 center pivot pin (2 pins)
- 10 Number 2 inner arm
- 11 Number 2 pivot pin (steer-end)
- 12 Number 1 center pivot pin

- 13 Number 1 inner arm
- 14 Number 1 pivot pin (steer-end)
- 15 Number 5 pivot pin (non-steer end)
- 16 Number 4 outer arm
- 17 Number 4 pivot pin (non-steer end)
- 18 Number 3 outer arm
- 19 Number 3 pivot pin (non-steer end)
- 20 Number 2 outer arm
- 21 Number 2 pivot pin (non-steer end)
- 22 Lift cylinder barrel-end pin
- 23 Number 1 outer arm

## SCISSOR COMPONENTS

### 3-4 Scissor Assembly, GS-1930 Models (after serial number 631)

#### How to Disassemble the Scissor Assembly GS-1930 Models (after serial number 631)

**▲WARNING** This procedure requires specific repair skills, lifting equipment and a suitable workshop. Attempting this procedure without these skills and tools may result in death or serious injury and significant component damage. Dealer service is required.

**NOTICE** When removing a hose assembly or fitting, the O-ring on the fitting and/or hose end must be replaced and then torqued to specification during installation. Refer to Section Two, *Hydraulic Hose and Fitting Torque Specifications*.

- 1 Remove the platform. See 2-1, *How to Remove the Platform*.
- 2 Remove the cables from the side of the number 4 outer arm (index #16) at the ground controls side.

**▲CAUTION** Component damage hazard. Cables can be damaged if they are kinked or pinched.

- 3 Attach a lifting strap from an overhead crane to the number 4 outer arm (index #16).
- 4 Remove the external snap rings from the number 4 center pivot pin (index #2).
- 5 Use a soft metal drift to remove the number 4 center pivot pin (index #2).
- 6 Remove the external snap rings from the number 4 pivot pin (index #17).
- 7 Use a soft metal drift to remove the number 4 pivot pin (index #17). Remove the number 4 outer arm (index #16) from the machine.

**▲CAUTION** Bodily injury hazard. The number 4 outer arm (index #16) may become unbalanced and fall if not properly supported when it is removed from the machine.

- 8 Remove the cable clamps from the upper cable tray on the number 4 inner arm (index #3).
- 9 Remove the mounting fasteners from the upper cable tray supports.
- 10 Remove the upper cable tray from the scissor assembly. Lay the cables off to the side of the machine.

**▲CAUTION** Component damage hazard. Cables can be damaged if they are kinked or pinched.

- 11 Attach a lifting strap from an overhead crane to the number 4 inner arm (index #3).
- 12 Remove the external snap rings from the number 4 pivot pin (index #4) at the steer end of the machine.

## SCISSOR COMPONENTS

13 Use a soft metal drift to remove the number 4 pivot pin (index #4) at the steer end. Remove the number 4 inner arm (index #3) from the machine.

**CAUTION** Bodily injury hazard. The number 4 inner arm (index #3) may become unbalanced and fall if not properly supported when it is removed from the machine.

14 Attach a lifting strap from an overhead crane to the number 3 outer arm (index #18).

15 Remove the external snap rings from the number 3 center pivot pin (index #5).

16 Use a soft metal drift to remove the number 3 center pivot pin (index #5).

17 Remove the external snap rings from the number 3 pivot pin (index #19) from the non-steer end of the machine.

18 Use a soft metal drift to remove the number 3 pivot pin (index #19) from the non-steer end of the machine. Remove the number 3 outer arm (index #18) from the machine.

**CAUTION** Bodily injury hazard. The number 3 outer arm (index #18) may become unbalanced and fall if not properly supported when it is removed from the machine.

19 Attach a lifting strap from an overhead crane to lug on the rod end of the lift cylinder.

20 Remove the pin retaining fasteners from the cylinder rod-end pivot pin (index #6). Use a soft metal drift to remove the pin.

**CAUTION** Bodily injury hazard. The cylinder may fall if not properly supported when the pin is removed.

21 Lower the cylinder onto the number 1 center pivot pin (index #12).

22 Remove the cables from the number 3 inner arm (index #7) and lay them off to the side.

23 Attach a lifting strap from an overhead crane to number 3 inner arm (index #7).

24 Remove the external snap rings from the number 3 pivot pin at the steer end (index #8).

25 Use a soft metal drift to remove the number 3 pivot pin (index #8). Remove the number 3 inner arm (index #7) from the machine.

**CAUTION** Bodily injury hazard. The number 3 inner arm (index #7) may become unbalanced and fall if not properly supported when it is removed from the machine.

26 Remove the cable clamps from the lower cable tray. Lay the cables off to the side of the machine.

**CAUTION** Component damage hazard. Cables can be damaged if they are kinked or pinched.

27 Attach a strap from an overhead crane to the number 2 outer arm (index #20).

28 Remove the mounting fasteners from the lower cable tray supports.

## SCISSOR COMPONENTS

- 29 Remove the external snap rings from the number 2 center pivot pin (index #9) at the ground controls side.
- 30 Remove the external snap rings from the number 2 center pivot pin (index #9) at the battery pack side.
- 31 Use a soft metal drift to remove both of the number 2 center pivot pins (index #9).
- 32 Remove the external snap rings from the number 2 pivot pin (index #21) at the non-steer end of the machine.
- 33 Use a soft metal drift to remove the number 2 pivot pin (index #21). Remove the number 2 outer arm (index #20) from the machine.

**CAUTION** Bodily injury hazard. The number 2 outer arm (index #20) may become unbalanced and fall if not properly supported when it is removed from the machine.

- 34 Attach a lifting strap from an overhead crane to the number 2 inner arm (index #10).
- 35 Remove the external snap rings from the number 2 pivot pin (index #11) at the steer end of the machine.
- 36 Use a soft metal drift to remove the number 2 pivot pin (index #11). Remove the number 2 inner arm (index #10) from the machine.

**CAUTION** Bodily injury hazard. The number 2 inner arm (index #10) may become unbalanced and fall if not properly supported when it is removed from the machine.

- 37 Remove the safety arm from the number 2 inner arm (index #10) that was just removed.
- 38 Attach the strap from the overhead crane to the number 1 inner arm (index #13).
- 39 Raise the number 1 inner arm (index #13) approximately 2 feet (0.6 m) and insert the safety arm between the number 1 inner arm (index #13) and the number 1 outer arm (index #23).

**CAUTION** Bodily injury hazard. Keep hands clear of moving parts when inserting the safety arm.

- 40 Disconnect and plug the hydraulic hose on the lift cylinder. Cap the fitting on the cylinder.

**WARNING** Bodily injury hazard. Spraying hydraulic oil can penetrate and burn skin. Loosen hydraulic connections very slowly to allow the oil pressure to dissipate gradually. Do not allow oil to squirt or spray.

- 41 Tag and disconnect the wires from the solenoid valve on the cylinder.
- 42 Attach the strap from an overhead crane to the lug on the rod end of the lift cylinder.
- 43 Remove the pin retaining fasteners from the cylinder barrel-end pivot pin (index #22). Use a soft metal drift to remove the pin. Remove the cylinder from the machine.

**WARNING** Crushing hazard. If the overhead crane is not properly attached, the cylinder may become unbalanced and fall when it is removed from the machine.

## SCISSOR COMPONENTS

**CAUTION** Component damage hazard. Be careful not to damage the valve or fittings on the cylinder while removing it from the machine.

- 44 Place a 4 x 4 x 32 inch (10 x 10 x 81 cm) long block across both sides of the chassis under the number 1 center pivot pin (index number #12).
- 45 Attach the strap from the overhead crane to the number 1 inner arm (index #13). Raise the inner arm slightly and remove the safety arm. Lower the arms on to the block.

**CAUTION** Bodily injury hazard. Keep hands clear of moving parts when lowering the arms onto the block.

- 46 Remove the cables from the number 1 inner arm (index #13) and lay them off to the side.

**CAUTION** Component damage hazard. Cables can be damaged if they are kinked or pinched.

- 47 Remove the fasteners from the entry ladder and remove the entry ladder.
- 48 Attach the strap from the overhead crane to the number 1 outer arm (index #23). Do not lift it.
- 49 Remove the external snap rings from the number 1 center pivot pin (index #12).
- 50 Use a soft metal drift to remove the number 1 center pivot pin (index #12).

**CAUTION** Bodily injury hazard. The number 1 outer arm (index #23) may become unbalanced and fall if not properly supported when the pin is removed.

- 51 Slide the number 1 outer arm (index #23) to the non-steer end and remove it from the machine.

**CAUTION** Bodily injury hazard. The number 1 outer arm (index #23) may become unbalanced and fall if not properly supported when removing it from the machine.

**NOTICE** Note the position of the wear pads before the arm is removed so when the scissor is assembled they will be in the correct position.

- 52 Attach the strap from an overhead crane to the number 1 inner arm (index #13). Do not lift it.

- 53 Remove the pin retaining fasteners from both of the number 1 pivot pins (index #14) at the steer end of the machine. Use a slide hammer to remove the pins.

- 54 Remove the number 1 inner arm (index #13) from the machine.

**CAUTION** Bodily injury hazard. The number 1 inner arm (index #13) may become unbalanced and fall if not properly supported when removed from the machine.

**CAUTION** Component damage hazard. Be sure not to damage the limit switch or level sensor box components when the number 1 inner arm (index #13) is removed from the machine.

## SCISSOR COMPONENTS

## How to Replace the Scissor Arm Wear Pads (after serial number 631)

- 1 Remove the platform. See 2-1, *How to Remove the Platform*.
- 2 Remove the mounting fasteners from the stationary wear pads on the platform.

**NOTICE** Note the position of the old wear pads before they are removed so when the new ones are installed they will be in the correct position.

- 3 Remove the fasteners from the entry ladder and remove the entry ladder.
- 4 Raise the platform approximately 7 to 8 feet (2.1 to 2.4 m).
- 5 Rotate the safety arm away from the machine.
- 6 Lower the platform onto the safety arm.
- 7 Mark the mounting position of the level sensor box on the drive chassis.
- 8 Remove the level sensor box lid.
- 9 Mark the mounting position of the level sensor on the level sensor box.
- 10 Remove the mounting fasteners from the level sensor.

- 11 Remove the fasteners from the level sensor box and slide it towards the non-steer end of the machine as far as it will go.

**CAUTION** Component damage hazard. Be careful not to damage the level sensor box, limit switch, level sensor or wiring while moving the level sensor box.

- 12 Secure the ends of the scissor arms together at both ends of the machine with a tie down strap or other appropriate device.
- 13 Remove the pin retaining fasteners from the number 1 inner arm pivot pins at the steer end of the machine. Use a slide hammer to remove the pins.
- 14 Attach a strap from an overhead crane to the steer end of the scissor arms.
- 15 Carefully slide the forks from a forklift under the scissor arms at the non-steer end of the machine.
- 16 Raise the scissor arms up until the number 1 inner arm will clear the level sensor box.

**CAUTION** Component damage hazard. Be careful not to damage the level sensor box, limit switch or level sensor while moving the scissor assembly.

- 17 Move the scissor assembly towards the non-steer end of the machine slightly and to one side of the machine until one of the scissor arm wear pads are accessible. Do not allow both wear pads to slide out of the drive chassis.

**DANGER** The scissor assembly will fall if both wear pads are allowed to slide out of the drive chassis.

## SCISSOR COMPONENTS

18 Install the new wear pad.

**NOTICE** Note the position of the old wear pad before it is removed so when the new one is installed it will be in the correct position.

19 Move the scissor assembly towards the other side of the machine until the other scissor arm wear pad is accessible.

**▲ DANGER** The scissor assembly will fall if both wear pads are allowed to slide out of the drive chassis.

20 Install the new wear pad.

**NOTICE** Note the position of the old wear pad before it is removed so when the new one is installed it will be in the correct position.

21 Slide the scissor assembly back into the drive chassis.

22 Lower the scissor assembly into position and install the pivot pins.

**▲ CAUTION** Component damage hazard. Be careful not to damage the level sensor box, limit switch or level sensor while installing the scissor assembly.

## 3-5 Lift Cylinder

### How to Remove the Lift Cylinder

**▲ WARNING** This procedure requires specific repair skills, lifting equipment and a suitable workshop. Attempting this procedure without these skills and tools may result in death or serious injury and significant component damage. Dealer service is strongly recommended.

**NOTICE** When removing a hose assembly or fitting, the O-ring on the fitting and/or hose end must be replaced and then torqued to specification during installation. Refer to Section Two, *Hydraulic Hose and Fitting Torque Specifications*.

- 1 Raise the platform approximately 7 to 8 feet (2.1 to 2.4 m).
- 2 Rotate the safety arm away from the machine.
- 3 Lower the platform onto the safety arm.

**▲ WARNING** Crushing hazard. Keep hands clear of the safety arm when lowering the platform.

- 4 Tag and disconnect the wiring from the solenoid at the barrel end of the lift cylinder.
- 5 Loosen the adjustment nuts on the solenoid, then disconnect the manual lowering cable from the solenoid.

**NOTICE** During assembly, the manual platform lowering cable needs to be properly adjusted. Refer to 4-1, *How to Adjust the Manual Platform Lowering Cable*.

- 6 Remove the mounting fasteners from the manual lowering cable mounting bracket. Remove the bracket from the cylinder.

## SCISSOR COMPONENTS

- 7 Disconnect and plug the hydraulic hardline from the lift cylinder. Cap the fitting on the cylinder.

**⚠ WARNING** Bodily injury hazard. Spraying hydraulic oil can penetrate and burn skin. Loosen hydraulic connections very slowly to allow the oil pressure to dissipate gradually. Do not allow oil to squirt or spray.

- 8 Remove the hardline retaining strap from the cylinder.
- 9 Attach a strap from an overhead crane or similar lifting device to the rod end of the lift cylinder for support.
- 10 Remove the external snap ring from the lift cylinder rod-end pivot pin. Then use a soft metal drift to remove the pin.

**⚠ WARNING** Crushing hazard. The lift cylinder will fall if not properly supported.

**⚠ CAUTION** Component damage hazard. Be careful not to damage the level sensor box, limit switch or level sensor while lowering the cylinder.

- 11 Lower the cylinder.
- 12 Remove the fasteners from the entry ladder and remove the entry ladder.
- 13 Support the barrel end of the lift cylinder with a lifting device.
- 14 Remove the external snap ring from the lift cylinder barrel-end pivot pin. Then use a soft metal drift to remove the pin.

**⚠ WARNING** Crushing hazard. The lift cylinder will fall if not properly supported.

- 15 Carefully pull the cylinder out the non-steer end of the machine through the scissor arms.

## How to Check the Resistance of a Valve Coil

- 1 Turn the key switch to the OFF position and disconnect the wires from the valve coil to be tested.
- 2 Connect the positive lead from the ohmmeter to the valve coil terminal, then connect the negative lead from the ohmmeter to the internal ring of the valve coil.

---

### Platform lowering valve coil specifications

---

2 position 2 way N.C. solenoid valve - 20V	23 - 25Ω
--	----------

(schematic item R)

---

# Ground Controls

## 4-1 Manual Platform Lowering Cable

The manual platform lowering cable lowers the platform in the event of a main power failure. The manual platform lowering cable is attached to the barrel end of the lift cylinder and is activated next to the ground controls.

### How to Adjust the Manual Platform Lowering Cable

- 1 Raise the platform approximately 7 to 8 feet (2.1 to 2.4 m).
- 2 Rotate the safety arm away from the machine.
- 3 Lower the platform onto the safety arm.

**⚠ WARNING** Crushing hazard. Keep hands clear of the safety arm when lowering the platform.

- 4 Push the handle on the manual platform lowering cable all the way in.
- 5 Disconnect the cable mounting nut from the lowering valve at the barrel end of the lift cylinder.
- 6 Pull the cable tight and measure the distance between the end of the lowering cable and the end of the lowering valve.
  - ⊙ Result: The measurement should be  $\frac{3}{16}$  to  $\frac{1}{4}$  inch (4.7 to 6.4 mm).
- 7 To adjust, loosen the upper lock nut on the cable mounting bracket. Turn the lower lock nut clockwise to decrease the distance or counterclockwise to increase the distance.
- 8 Tighten the upper lock nut and re-measure the distance between the end of the lowering cable and the end of the lowering valve. Re-adjust if needed.
- 9 Install the cable mounting nut onto the lowering valve.

- 10 Raise the platform and rotate the safety arm to the storage position.

- 11 Pull the manual lowering handle at the ground controls 2 to 3 times to ensure it is functioning correctly.

<b>Cable distance</b>	$\frac{3}{16}$ to $\frac{1}{4}$ inch 4.7 to 6.4 mm
-----------------------	---

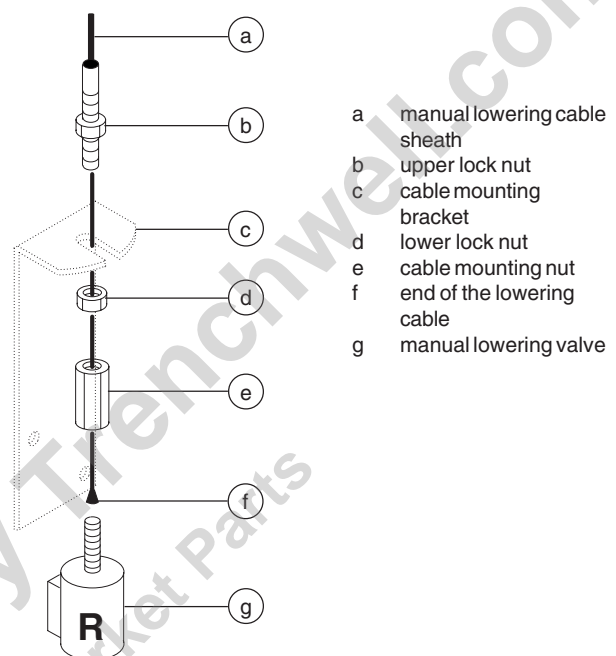

- a manual lowering cable sheath
- b upper lock nut
- c cable mounting bracket
- d lower lock nut
- e cable mounting nut
- f end of the lowering cable
- g manual lowering valve

## 4-2 Toggle Switches

See 1-3, *Toggle Switches*.

# Hydraulic Pump

## 5-1 Function Pump

The hydraulic pump is attached to the motor which makes up the Hydraulic Power Unit.

### How to Test the Hydraulic Pump

**NOTICE** When removing a hose assembly or fitting, the O-ring on the fitting and/or hose end must be replaced and then torqued to specification during installation. Refer to Section Two, *Hydraulic Hose and Fitting Torque Specifications*.

- 1 Disconnect and plug the high pressure hydraulic hose from the hydraulic pump.

**AWARNING** Bodily injury hazard. Spraying hydraulic oil can penetrate and burn skin. Loosen hydraulic connections very slowly to allow the oil pressure to dissipate gradually. Do not allow oil to squirt or spray.

- 2 Connect a 0 to 5000 psi (0 to 350 bar) pressure gauge to the high pressure port on the pump.
- 3 Turn the key switch to ground control and pull the Emergency Stop button to the ON position.
- 4 Activate the platform up function from the ground controls.
- ⊙ Result: If the pressure gauge reads 3700 psi (255 bar), immediately stop. The pump is good.
- ⊙ Result: If pressure fails to reach 3700 psi (255 bar), the pump is bad and will need to be serviced or replaced.
- 5 Remove the pressure gauge and reconnect the hydraulic hose.

### How to Remove the Hydraulic Pump

**NOTICE** When removing a hose assembly or fitting, the O-ring on the fitting and/or hose end must be replaced and then torqued to specification during installation. Refer to Section Two, *Hydraulic Hose and Fitting Torque Specifications*.

- 1 Remove the mounting fasteners from the hydraulic filter bracket at the function manifold. Push the filter off to the side.
- 2 Tag, disconnect and cap the hydraulic hoses on the pump.

**AWARNING** Bodily injury hazard. Spraying hydraulic oil can penetrate and burn skin. Loosen hydraulic connections very slowly to allow the oil pressure to dissipate gradually. Do not allow oil to squirt or spray.

- 3 Remove the pump mounting bolts. Carefully remove the pump.

# Function Manifold

## 6-1

### Function Manifold Components

The function manifold is mounted inside the hydraulic power unit module.

Index No.	Description	Schematic Item	Function	Torque
1	Flow regulator, 0.5 gpm (1.9 L/min) .. A .....	A	Steer circuit .....	35-40 ft-lbs (47-54 Nm)
2	Orifice washer, 0.040 in (1 mm) ..... B .....	B	Steer circuit	
3	Relief valve, 1200 psi (82.7 bar) ..... C .....	C	Steering relief .....	25-30 ft-lbs (34-41 Nm)
4	Relief valve, GS-1530, 3200 psi (220.6 bar) ..... D .....	D	System relief .....	25-30 ft-lbs (34-41 Nm)
	GS-1930, 3700 psi (255.1 bar) ..... D .....	D	System relief .....	25-30 ft-lbs (34-41 Nm)
5	Orifice plug, 0.025 in (0.6 mm) ..... E .....	E	Brake circuit	
6	3 position 4 way solenoid valve..... F .....	F	Steer left/right .....	18-20 ft-lbs (24-27 Nm)
7	2 position 4 way solenoid valve..... G .....	G	Platform up .....	23-25 ft-lbs (31-34 Nm)
8	Orifice washer, 0.060 in (1.5 mm) .... H .....	H	Brake circuit	
9	2 position 2 way solenoid valve, N. O. .... I .....	I	Brake circuit .....	18-20 ft-lbs (24-27 Nm)
10	3 position 4 way solenoid valve..... J .....	J	Drive forward/reverse .....	18-20 ft-lbs (24-27 Nm)
11	Check valve .....	K	Brake circuit .....	35-40 ft-lbs (47-54 Nm)
12	Check valve (machines after serial number 1885 only) .....	L	Steer circuit .....	35-40 ft-lbs (47-54 Nm)
13	Diagnostic fitting .....	M	Testing	

### Plug Torque Specifications

Description	Hex Size	Torque
SAE No. 2	1/8	50 in-lbs / 6 Nm
SAE No. 4	3/16	13 ft-lbs / 18 Nm
SAE No. 6	1/4	18 ft-lbs / 24 Nm

Description	Hex Size	Torque
SAE No. 8	5/16	50 ft-lbs / 68 Nm
SAE No. 10	9/16	55 ft-lbs / 75 Nm
SAE No. 12	5/8	75 ft-lbs / 102 Nm

FUNCTION MANIFOLD

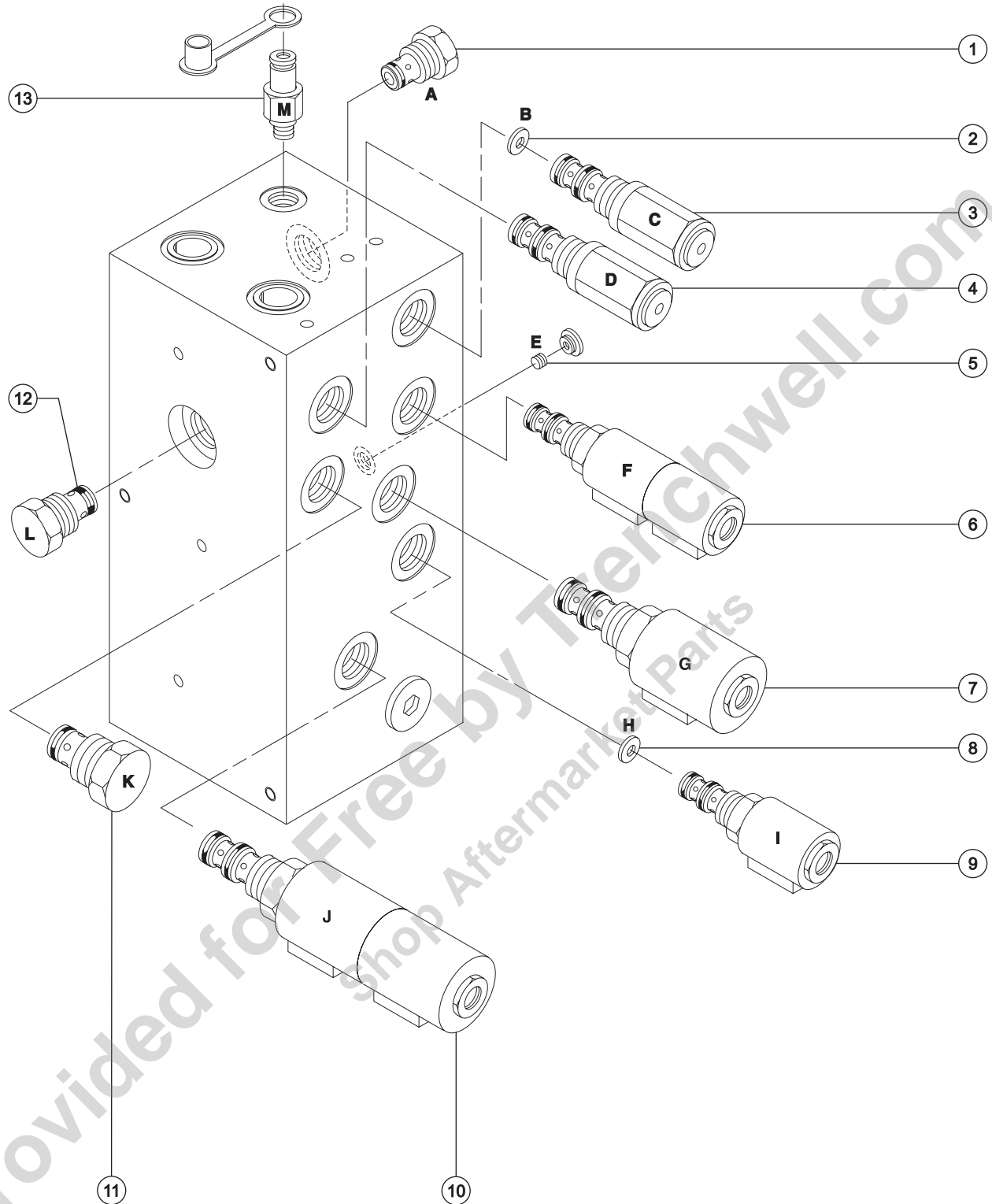

## FUNCTION MANIFOLD

## 6-2 Valve Adjustments - Function Manifold

### How to Adjust the Function Relief Valve

**NOTICE** Be sure that the hydraulic oil level is between the FULL and ADD marks on the oil level indicator decal.

- 1 Open the hydraulic power unit module tray and locate the function relief valve on the function manifold.
- 2 Place maximum rated load into the platform. Secure the load to the platform.

#### Maximum Capacity

GS-1530	600 lbs	272 kg
GS-1930	500 lbs	227 kg

- 3 Hold the function relief valve with a wrench and remove the cap (item 4, function manifold).
- 4 While activating the platform up function, adjust the internal hex socket clockwise, just until the platform begins to raise.
- 5 Fully lower the platform.
- 6 Add an additional 50 pounds (22.7 kg) to the platform. Secure the additional weight.
- 7 Raise the platform slightly.
- 8 The power unit should **not** be able to lift the platform. If the power unit lifts the platform, adjust the internal hex socket counterclockwise until the adjustment is correct.
- 9 Install the relief valve cap.

- 10 Bleed the hydraulic system by raising the platform to full height. If the pump cavitates or platform fails to reach full height, add hydraulic oil until the pump is functioning correctly. Do not overfill the hydraulic reservoir.

**CAUTION** Component damage hazard. Do not continue to operate the machine if the hydraulic pump is cavitating.

### How to Adjust the Steering Relief Valve

- 1 Open the hydraulic power unit module tray and locate the steering relief valve on the function manifold.
- 2 Connect a 0 to 5000 psi (0 to 350 bar) pressure gauge to the test port on the function manifold.
- 3 Turn the key switch to ground control and pull out the Emergency Stop button to the ON position at both the ground and platform controls.
- 4 Activate the function enable switch and press and hold the steer thumb rocker switch to the right. Allow the wheels to completely turn to the right, then continue holding the switch while observing the pressure reading on the pressure gauge. Note the pressure.
- 5 Press and hold the steer thumb rocker switch to the left. Allow the wheels to completely turn to the left, then continue holding the switch while observing the pressure reading on the pressure gauge.
- 6 Turn the machine off. Hold the steer relief valve with a wrench and remove the cap (item 3, function manifold).

## FUNCTION MANIFOLD

- 7 Adjust the internal hex socket. Turn it clockwise to increase the pressure or counterclockwise to decrease the pressure. Install the relief valve cap.

**WARNING** Tip-over hazard. Do not adjust the relief valves higher than recommended.

- 8 Repeat steps 3 through 6 to recheck the valve pressure.

---

**Steering relief valve specification**

---

Pressure	1200 psi	82.8 bar
----------	----------	----------

---

### How to Check the Resistance of a Valve Coil

- 1 Turn the key switch to the OFF position and disconnect the wire from the valve coil to be tested.
- 2 Connect the positive lead from the ohmmeter to the valve coil terminal, then connect the negative lead from the ohmmeter to the internal ring of the valve coil.

---

**Function manifold valve coil specifications**

---

3 position 4 way solenoid valve (schematic item <b>F</b> )	26 - 28 <b>W</b>
2 position 2 way solenoid valve (schematic item <b>I</b> )	26 - 28 <b>W</b>
2 position 4 way solenoid valve (schematic item <b>G</b> )	18 - 20 <b>W</b>
3 position 4 way solenoid valve (schematic item <b>J</b> )	18 - 20 <b>W</b>

---

# Steering Axle Components

## 7-1

### Yoke and Drive Motor

#### How to Remove the Yoke and Drive Motor

**NOTICE** When removing a hose assembly or fitting, the O-ring on the fitting and/or hose end must be replaced and then torqued to specification during installation. Refer to Section Two, *Hydraulic Hose and Fitting Torque Specifications*.

- 1 Block the non-steer wheels and center a lifting jack under the drive chassis at the steer end.
- 2 Remove the cotter pin from the wheel castle nut.

**NOTICE** Always replace the cotter pin with a new one when removing the castle nut.

- 3 Loosen the wheel castle nut. Do not remove it.
- 4 Raise the machine approximately 14 inches (35.6 cm). Place blocks under the chassis for support.

**AWARNING** Crushing hazard. The chassis will fall if it is not properly supported.

- 5 Remove the castle nut, then remove the wheel.
- 6 Tag, disconnect and cap the hydraulic hoses on the drive motor.

**AWARNING** Bodily injury hazard. Spraying hydraulic oil can penetrate and burn skin. Loosen hydraulic connections very slowly to allow the oil pressure to dissipate gradually. Do not allow oil to squirt or spray.

- 7 Support the yoke assembly with a lifting device.
- 8 Remove the retaining fastener that fastens the steer link to the bellcrank.

**NOTICE** Note the quantity and location of the spacers when disconnecting the steer link from the bellcrank.

- 9 Remove the retaining fastener from the top of the yoke pivot shaft.
- 10 Lower the yoke assembly out of the chassis.

**CAUTION** Bodily injury hazard. The yoke/motor assembly may fall if not properly supported when it is removed from the chassis.

#### Torque specifications

Castle nut	300 ft-lbs 406.7 Nm
------------	------------------------

#### How to Remove a Drive Motor

- 1 Block the non-steer wheels and center a lifting jack under the drive chassis at the steer end.
- 2 Remove the cotter pin on the wheel lug nut of the motor to be removed.

**NOTICE** Always replace the cotter pin with a new one when removing the castle nut.

- 3 Loosen the wheel castle nut. Do not remove it.

## STEERING AXLE COMPONENTS

- 4 Raise the machine approximately 2 inches (5.1 cm). Place blocks under the chassis for support.
- 5 Remove the castle nut, then remove the wheel.
- 6 Tag, disconnect and cap the hydraulic hoses on the drive motor.

**▲WARNING** Bodily injury hazard. Spraying hydraulic oil can penetrate and burn skin. Loosen hydraulic connections very slowly to allow the oil pressure to dissipate gradually. Do not allow oil to squirt or spray.

- 7 Remove the drive motor mounting fasteners, then remove the motor.

---

**Torque specifications**

---

Castle nut	300 ft-lbs 406.7 Nm
------------	------------------------

---

## 7-2 Steering Cylinder

---

### How to Remove the Steering Cylinder

**NOTICE** When removing a hose assembly or fitting, the O-ring on the fitting and/or hose end must be replaced and then torqued to specification during installation. Refer to Section Two, *Hydraulic Hose and Fitting Torque Specifications*.

- 1 Tag, disconnect and plug the hydraulic hoses from the steering cylinder. Cap the fittings on the cylinder.

**▲CAUTION** Bodily injury hazard. Spraying hydraulic oil can penetrate and burn skin. Loosen hydraulic connections very slowly to allow the oil pressure to dissipate gradually. Do not allow oil to squirt or spray.

- 2 Remove the pin retaining fasteners from the barrel-end pivot pin. Remove the pivot pin.

**NOTICE** Note the quantity and location of the spacers when removing the barrel-end pivot pin.

- 3 Remove the pin retaining fasteners from the rod-end pivot pin. Remove the pin.

**NOTICE** Note the quantity and location of the spacers when removing the rod-end pivot pin.

- 4 Remove the steering cylinder from the machine.

## STEERING AXLE COMPONENTS

### 7-3 Steering Bellcrank (before serial number 2000)

- 1 Remove the steering cylinder. See 7-2, *How to Remove the Steering Cylinder*.
- 2 Remove the pin retaining fastener from the bellcrank center pivot pin. Remove the pin.
- 3 Support one drive yoke/motor assembly with a lifting device.
- 4 Remove the retaining fastener from the yoke pivot shaft.
- 5 Place a block under the yoke/motor assembly that is being removed. Lower the yoke assembly approximately 3 inches (7.6 cm) to allow the steer link to clear the pivot shaft on the yoke.

**CAUTION** Bodily injury hazard. The yoke/motor assembly may fall if not properly supported when it is lowered from the chassis.

- 6 Lower the yoke assembly on to the block for support.

**CAUTION** Component damage hazard. When the bellcrank is installed, be sure the steering cylinder hoses are placed between the bellcrank and the bottom of the drive chassis.

- 7 Remove the pin retaining fasteners from the bellcrank pivot pin. Remove the pin.
- 8 Repeat steps 4 through 7 for other yoke/motor assembly. Remove the bellcrank.

### 7-4 Steering Bellcrank (after serial number 1999)

**NOTICE** When removing a hose assembly or fitting, the O-ring on the fitting and/or hose end must be replaced and then torqued to specification during installation. Refer to Section Two, *Hydraulic Hose and Fitting Torque Specifications*.

- 1 Tag, disconnect and plug the hydraulic hoses from the steering cylinder. Cap the fittings on the cylinder.

**WARNING** Bodily injury hazard. Spraying hydraulic oil can penetrate and burn skin. Loosen hydraulic connections very slowly to allow the oil pressure to dissipate gradually. Do not allow oil to squirt or spray.

- 2 Remove the pin retaining fasteners from the rod-end pivot pin of the steer cylinder. Remove the pin.

**NOTICE** Note the quantity and location of the spacers when removing the rod-end pivot pin.

- 3 Remove the retaining fastener from the center pivot pin of the bellcrank.

**NOTICE** Note the quantity and the location of the spacers on the bellcrank.

- 4 Remove the retaining fasteners from the steer links at each end of the bellcrank. Remove the bellcrank from the machine.

**NOTICE** Note the quantity and the location of the spacers in between the bellcrank and the steer links.

# Non-steering Axle Components

## 8-1 Drive Brake

### How to Remove a Drive Brake

**NOTICE** When removing a hose assembly or fitting, the O-ring on the fitting and/or hose end must be replaced and then torqued to specification during installation. Refer to Section Two, *Hydraulic Hose and Fitting Torque Specifications*.

- 1 Remove the fasteners from the entry ladder and remove the entry ladder.
- 2 Block the steer wheels and center a lifting jack under the drive chassis at the non-steer end.
- 3 Remove the cotter pin from the wheel castle nut.

**NOTICE** Always replace the cotter pin with a new one when removing the castle nut.

- 4 Loosen the wheel castle nut. Do not remove it.
- 5 Raise the machine 2 inches (5.1 cm) and place blocks under the drive chassis for support.
- 6 Remove the wheel castle nut, then remove the wheel.
- 7 Disconnect the hydraulic hose from the brake and plug it. Cap the fitting on the brake.

**AWARNING** Bodily injury hazard. Spraying hydraulic oil can penetrate and burn skin. Loosen hydraulic connections very slowly to allow the oil pressure to dissipate gradually. Do not allow oil to squirt or spray.

- 8 Place a second lifting jack under the brake for support.

- 9 Remove the fasteners that attach the brake to the drive chassis, then remove the brake.

**CAUTION** Crushing hazard. The brake will fall if it is not properly supported when the mounting fasteners are removed.

#### Torque specifications

Castle nut	300 ft-lbs 406.7 Nm
------------	------------------------

# Brake Release Hand Pump Components

## 9-1

### Brake Release Hand Pump Components

The brake release handpump manifold is mounted behind the entry ladder next to the battery charger.

Index No.	Description	Schematic Item	Function	Torque
1	Check valve, pilot operated .....	N .....	Manual brake release .....	25-30 ft-lbs (34-41 Nm)
2	Shuttle valve .....	O .....	Brake release .....	8-10 ft-lbs (11-14 Nm)
3	Hand pump .....	P .....	Manual brake release .....	25-30 ft-lbs (34-41 Nm)

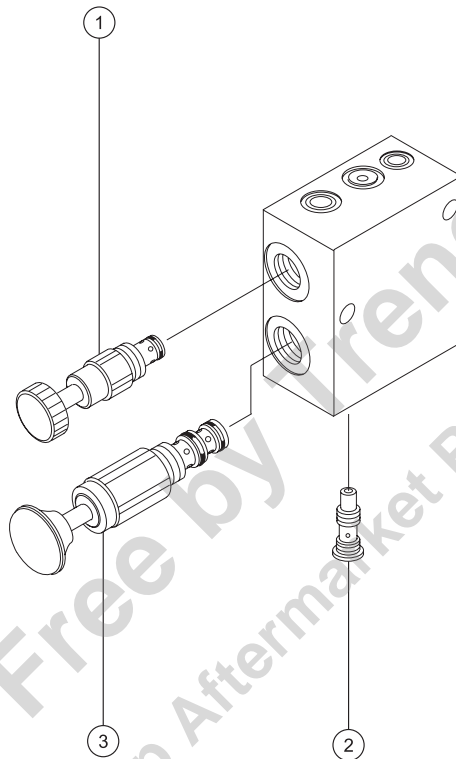

### Plug Torque Specifications

Description	Hex Size	Torque
SAE No. 2	1/8	50 in-lbs / 6 Nm
SAE No. 4	3/16	13 ft-lbs / 18 Nm
SAE No. 6	1/4	18 ft-lbs / 24 Nm

Description	Hex Size	Torque
SAE No. 8	5/16	50 ft-lbs / 68 Nm
SAE No. 10	9/16	55 ft-lbs / 75 Nm
SAE No. 12	5/8	75 ft-lbs / 102 Nm

Distributed By: \_\_\_\_\_



**Genie North America**

Phone: 425 881 1800  
Toll Free in USA 800 536 1800  
Toll Free in Canada 800 426 8089  
Fax: 425 883 3475

**Genie UK Limited**

Phone: 44 1636 605030  
Fax: 44 1636 611090

**Genie China**

Phone: 86 21 62483040  
Fax: 86 21 62588180

**Genie Japan**

Phone: 81 3 3453 6082  
Fax: 81 3 3453 6083

**Genie Australia Pty Ltd.**

Phone: 61 07 3375 1660  
Fax: 61 07 3375 1002

**Genie France**

Phone: 33 237 260 999  
Fax: 33 237 260 998

**Genie Holland**

Phone: 31 7051 78836  
Fax: 31 7051 13993

**Genie Latin America**

Phone: 561-994-0380  
Fax: 561-997-5877

Provided for Free by Trenchwell.com  
Step Aftermarket Parts